

18 Watt - Dimmable Driver

Project: _____ Date: _____
 Catalog #: _____
 Notes: _____

Key Features & Benefits:

- Universal AC Input / Full Range (up to 305 VAC)
- Built-in Active PFC Function
- Protections: Short Circuit / Over Voltage / Over Temperature
- Suitable for Dry / Damp Locations
- Easy Installation with ESL Vision Quick Connect Series
- 120 VAC Triac Compatible
- 7 Year Warranty



Technical Specifications:

Input

Input Voltage: 120 VAC
 Power Factor: 0.98 / 120 VAC, 0.90 / 277 VAC
 Total Harmonic Distortion: 20%
 Frequency Range: 47~63 Hz
 Efficiency: 87%
 AC Current: .150 A / 120 VAC, .065 A / 277 VAC

Output

DC Voltage: 36 VDC
 Rated Current: 435 mA
 Rated Power: 18W
 Voltage Range: 32 - 48 VDC
 Line Regulation: 3%
 Load Regulation: 2%

Environment

Working Temperature: -20 ~ 50°C
 Max Case Temperature: 81°C
 Working Humidity: 20 -70% RH

Driver Dimensions:

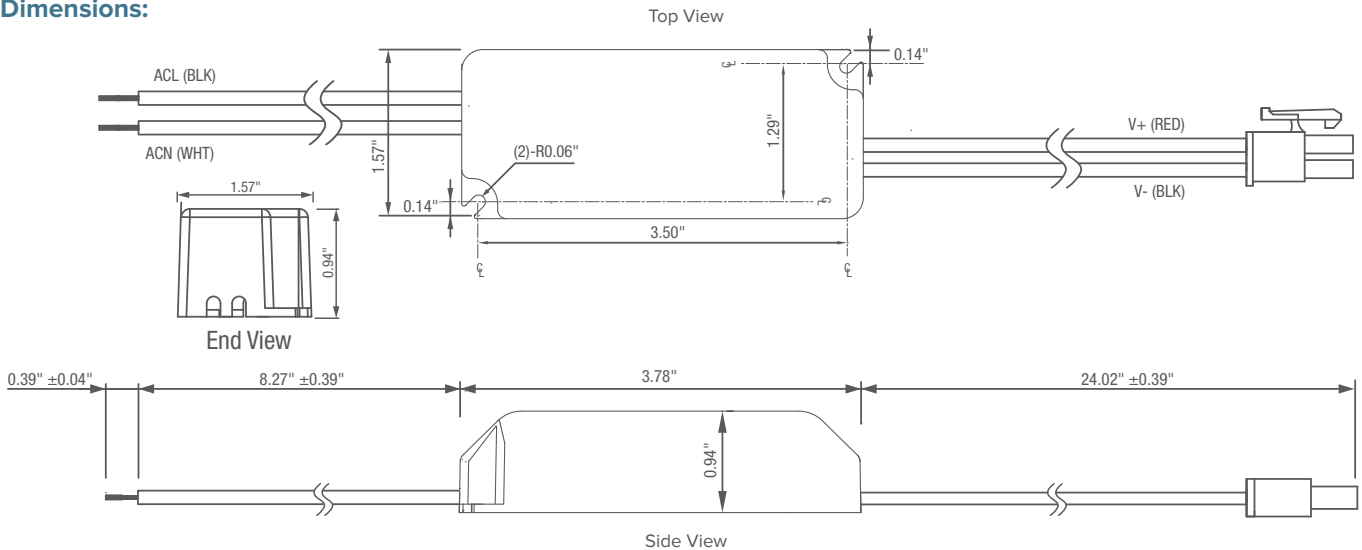

Example Part Number: **ESL-DQC1-18W-1L-TD**

ESL	-	DQC1	-	18W	-	1L	-	TD
ESL		DRIVER		WATTS		DC OUTPUT		DIMMING
		DQC1		10W 15W 18W 22W		1L		TD (Triac Dimming)