

## PAR20 - 7 Watts

Project: \_\_\_\_\_ Date: \_\_\_\_\_

Catalog #: \_\_\_\_\_

Notes: \_\_\_\_\_

### Key Features & Benefits:

- Energy Star listed
- >90 CRI
- 85% Energy savings
- 5 Year Warranty



### Technical Specifications:

- Power: 7 Watts
- Lumen Output: Up to 470
- Efficacy (lm/W): Up to 67 Lumens per Watt
- Correlated Color Temperature (CCT): 2700K, 3000K, 4000K, 5000K
- CRI: >90
- Input Voltage: 120 VAC
- Life Span: 25,000 Hours
- Beam Angle: 40°
- Dimensions(ØxH): 2.48" x 3.19"
- Base Type: E26

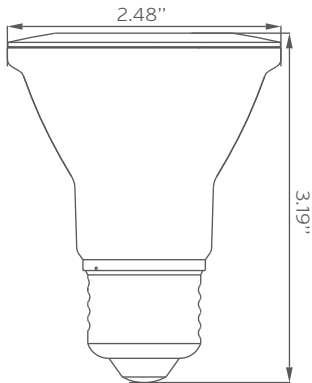

ITEM #	WATTS	LUMEN OUTPUT	EFFICACY (lm/W)	KELVIN	CRI	ENERGY STAR CERTIFIED
ESL-PAR20-7W-32740	7W	470	67	2700K	>90	✓
ESL-PAR20-7W-33040	7W	470	67	3000K	>90	✓
ESL-PAR20-7W-34040	7W	470	67	4000K	>90	✓
ESL-PAR20-7W-35040	7W	470	67	5000K	>90	✓

### Ordering Guide:

Example Part Number: **ESL-PAR20-7W-43040**

<b>ESL</b>	-	<b>PAR20</b>	-	<b>7W</b>	-	<b>3</b>	-	<b>40</b>
ESL		TYPE		WATTS		GENERATION		COLOR
		PAR20 (PAR20)		7W (7 Watts)		3 (Series 3)		27 (2700 Kelvin) 30 (3000 Kelvin) 40 (4000 Kelvin) 50 (5000 Kelvin)
								40 (40 Degrees)