

Key Features & Benefits:

- Multiple Mounting Options Designed to Retrofit:
 - Street Lights
 - High Bays and Low Bays
 - Garage Lights
 - Shoebox Fixtures
 - Wall Packs
- Utilize Existing Feature
- 10 Year Warranty
- Optimized Pin Array Heat Sink
- Overheat Shutdown
- L70 Lifetime > 80,000 Hours
- Intelligent Thermal Control
- Compatible with Networked Lighting Control Qualified Systems

Project: _____

Date: _____

Catalog #: _____

Notes: _____



Technical Specifications:

Light Specifications

Lumen Output: Up to 15,250 Lumens
 Efficacy (lm/W): Up to 127 Lumens per Watt
 Kelvin: 3000K, 4000K, 5000K
 CRI: >75
 Rated Life (hrs): 100,000 Hours
 IES Classification: Fixture Dependant
 Dimensions (LxWxH): 6.8"x4.9"x2.6"
 Weight Without Driver (lbs): 1.05

Driver Specifications

Power: 120 Watts
 Input Voltage: 120–277 VAC | HV 347–480 VAC
 Input Current @120V: 1.0A
 Input Current @277V: 0.43A
 Input Current @480V: 0.25A
 Operating Temperature: -40°F to 176°F (-40°C to 80°C)



Integrated-style kits that replace all reflectors and optical systems of existing luminaires. Not screw-in “lamps” intended as HID replacements.



Retrofit Kits for Outdoor Pole/Arm-Mounted Area and Roadway Luminaires

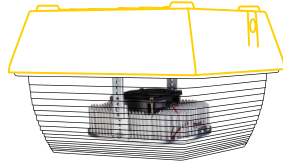

Retrofit Kits for Fuel Pump Canopy Luminairesz



Retrofit Kits for High-Bay Luminaires for Commercial and Industrial Buildings

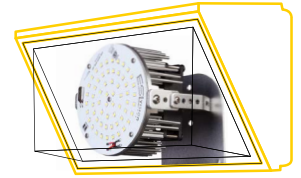

Retrofit Kits for Outdoor Full-Cutoff Wall-Mounted Luminaires

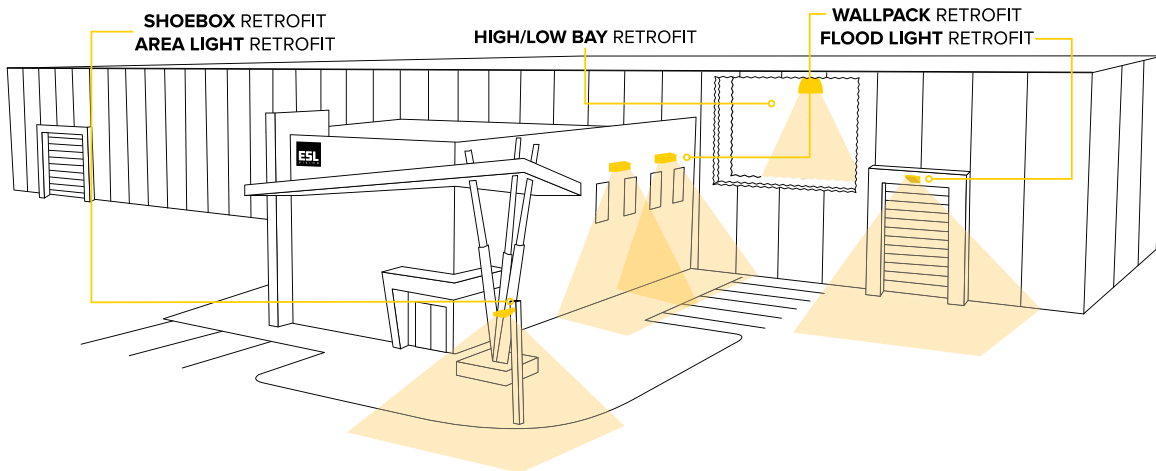

Ordering Guide:

ESL	-	TYPE	-	WATTS	-	GENERATION	-	KELVIN	-	VOLTAGE
ESL	-	MUR	-	120W	-	3	-	(xx)	-	(zz)
		(MUR) Multi-Use Retrofit		(120W) 120 Watts		(3) 3rd Generation		(30) 3000 Kelvin (40) 4000 Kelvin (50) 5000 Kelvin		(Blank) 120–277 VAC (HV) 347– 480 VAC

FIELD INSTALLED ACCESSORIES

ESL-3OCC	IP65 0–10v Dimming Sensor. 8’–50’ Mounting, Wire From Side
ESL-3OCCB	IP65 0–10v Dimming Sensor. 8’–50’ Mounting, Wire From Top
ESL-4OCC-LDD	Photocell/Occupancy Sensor for Standard Mounting, Dip Switch, 0–10v
ESL-SPD-277-1	Hard Wire Surge Protector; (100–277 VAC) Max Discharge Current: 20kA
ESL-REM-100	Hand Held Remote to Program 2OCC-HDD, 3OCC/B and 4OCC-LDD

Catalog Data:

ITEM#	WATTS	KELVIN	MAX LUMEN OUTPUT	EFFICACY (lm/W)	INPUT VOLTAGE	DLC QPL CODE
ESL-MUR-45W-330	45W	(30) 3000K	5542	120	120-277 VAC	PDUIMN20
ESL-MUR-45W-340		(40) 4000K	5,660	122	120-277 VAC	PH9CHOHS
ESL-MUR-45W-350		(50) 5000K	5,778	125	120-277 VAC	PJFK5QR
ESL-MUR-45W-330-HV	45W	(30) 3000K	5,416	120	277-480 VAC	P2ELDO0V
ESL-MUR-45W-340-HV		(40) 4000K	5,515	122	277-480 VAC	PA4091W9
ESL-MUR-45W-350-HV		(50) 5000K	5,615	125	277-480 VAC	PVW6L1BW
ESL-MUR-75W-330	75W	(30) 3000K	9,573	131	120-277 VAC	PA1OBGQ7
ESL-MUR-75W-340		(40) 4000K	9,774	134	120-277 VAC	PZYSYRH5
ESL-MUR-75W-350		(50) 5000K	9,974	136	120-277 VAC	PUIPKK8A
ESL-MUR-75W-330-HV	75W	(30) 3000K	9,613	131	277-480 VAC	P6ZLUL79
ESL-MUR-75W-340-HV		(40) 4000K	9,781	134	277-480 VAC	PVFXNJCG
ESL-MUR-75W-350-HV		(50) 5000K	9,949	136	277-480 VAC	PZ6E0MEQ
ESL-MUR-105W-330	105W	(30) 3000K	13,298	128	120-277 VAC	PA029GCY
ESL-MUR-105W-340		(40) 4000K	13,576	130	120-277 VAC	PQ2HQL77
ESL-MUR-105W-350		(50) 5000K	13,853	132	120-277 VAC	PT4HK5VN
ESL-MUR-105W-330-HV	105W	(30) 3000K	12,975	124	277-480 VAC	PW9VB0M0
ESL-MUR-105W-340-HV		(40) 4000K	13,182	126	277-480 VAC	PQZTGD62
ESL-MUR-105W-350-HV		(50) 5000K	13,400	128	277-480 VAC	P9D6B5C6
ESL-MUR-120W-330	120W	(30) 3000K	13,298	128	120-277 VAC	PA029GCY
ESL-MUR-120W-340		(40) 4000K	13,576	130	120-277 VAC	PQ2HQL77
ESL-MUR-120W-350		(50) 5000K	13,853	132	120-277 VAC	PT4HK5VN
ESL-MUR-120W-330-HV	120W	(30) 3000K	12,975	124	277-480 VAC	PW9VB0M0
ESL-MUR-120W-340-HV		(40) 4000K	13,182	126	277-480 VAC	PQZTGD62
ESL-MUR-120W-350-HV		(50) 5000K	13,400	128	277-480 VAC	P9D6B5C6
ESL-MUR-150W-330	150W	(30) 3000K	19,350	130	120-277 VAC	PH7YZY3D
ESL-MUR-150W-340		(40) 4000K	19,759	132	120-277 VAC	P8O6VD47
ESL-MUR-150W-350		(50) 5000K	20,168	134	120-277 VAC	PLAINCDA
ESL-MUR-150W-330-HV	150W	(30) 3000K	19,101	128	277-480 VAC	PWX6662L
ESL-MUR-150W-340-HV		(40) 4000K	19,400	130	277-480 VAC	P8YC9ZIU
ESL-MUR-150W-350-HV		(50) 5000K	19,709	132	277-480 VAC	PGSCGZ8L
ESL-MUR-200W-330	200W	(30) 3000K	25,087	122	120-277 VAC	P37E8RXB
ESL-MUR-200W-340		(40) 4000K	25,462	124	120-277 VAC	P87K6XAJ
ESL-MUR-200W-350		(50) 5000K	25,837	127	120-277 VAC	POMNBEFU
ESL-MUR-200W-330-HV	200W	(30) 3000K	25,029	121	277-480 VAC	PWOB3NAD
ESL-MUR-200W-340-HV		(40) 4000K	25,453	123	277-480 VAC	PBQDC85D
ESL-MUR-200W-350-HV		(50) 5000K	25,890	125	277-480 VAC	PKJ7S2H6
ESL-MUR-280W-330	280W	(30) 3000K	38,820	138	120-277 VAC	S-MC50QS
ESL-MUR-280W-340		(40) 4000K	39,343	140	120-277 VAC	S-LTXCOK
ESL-MUR-280W-350		(50) 5000K	39,866	141	120-277 VAC	S-2ZNP4R
ESL-MUR-280W-330-HV	280W	(30) 3000K	40,433	141	277-480 VAC	S-BQS8EM
ESL-MUR-280W-340-HV		(40) 4000K	40,956	143	277-480 VAC	S-XDR4HL
ESL-MUR-280W-350-HV		(50) 5000K	41,479	145	277-480 VAC	S-P1TBAD
ESL-MUR-350W-330	350W	(30) 3000K	46,649	133	120-277 VAC	S-M6GWTR
ESL-MUR-350W-340		(40) 4000K	47,295	135	120-277 VAC	S-523TH0
ESL-MUR-350W-350		(50) 5000K	47,941	137	120-277 VAC	S-WRXCPO
ESL-MUR-350W-330-HV	350W	(30) 3000K	47,558	138	277-480 VAC	S-098KXG
ESL-MUR-350W-340-HV		(40) 4000K	48,173	140	277-480 VAC	S-BXJL42
ESL-MUR-350W-350-HV		(50) 5000K	48,787	142	277-480 VAC	S-VMP2BU

*Not All Part Numbers DLC Qualified. For a Complete Listing Please Consult the DLC Qualified Products List (QPL).



Dimensions:

ESL-MUR-45W

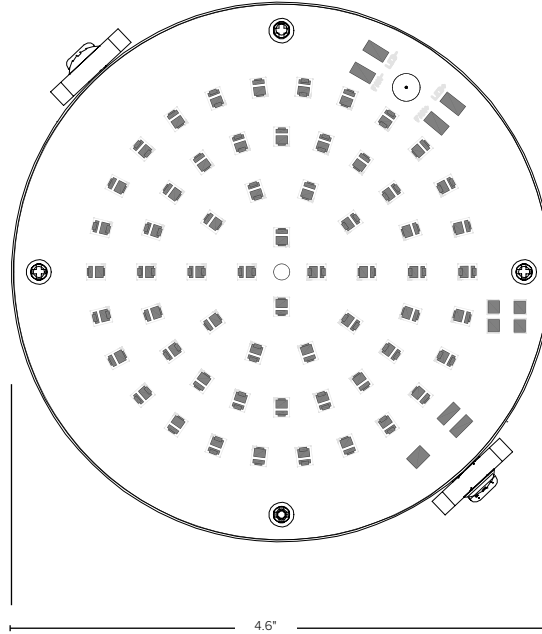
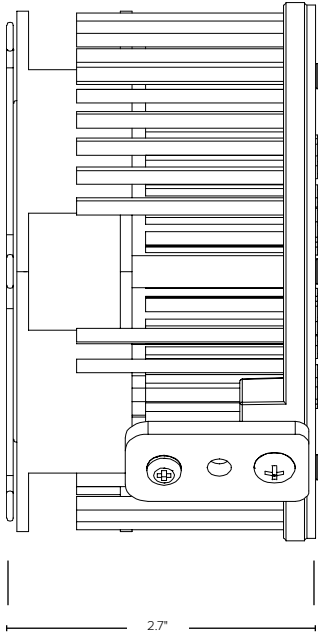

ESL-MUR-, 75W, 105W, 120W

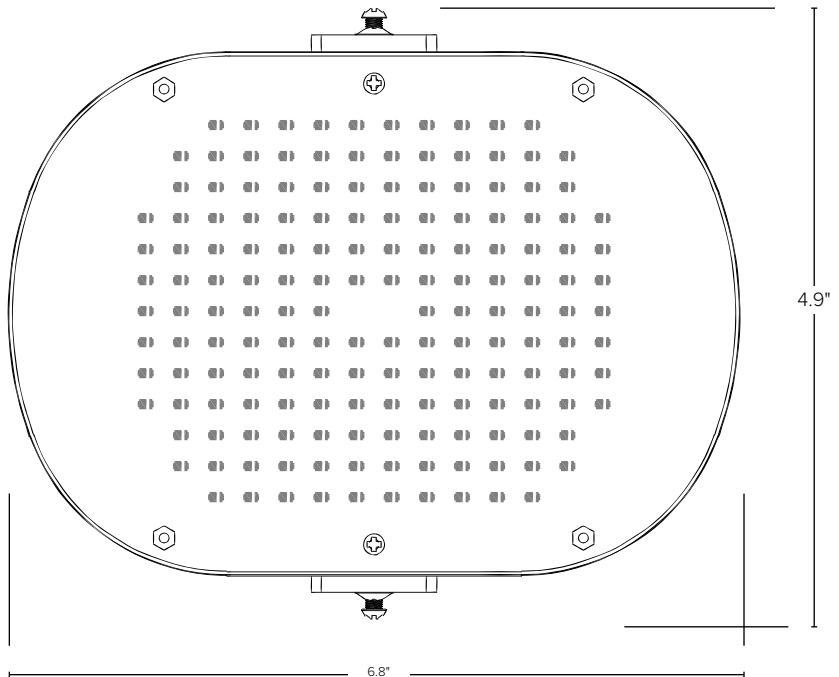
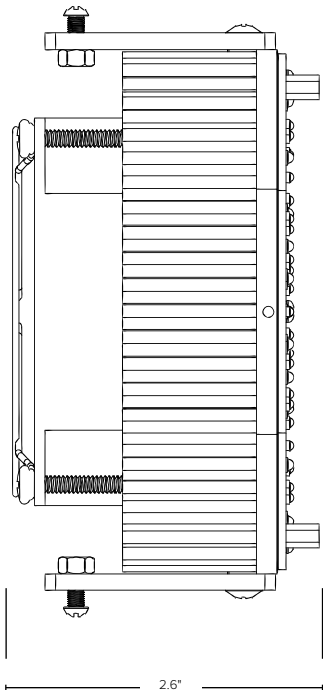

Dimensions:

ESL-MUR-150W, 200W

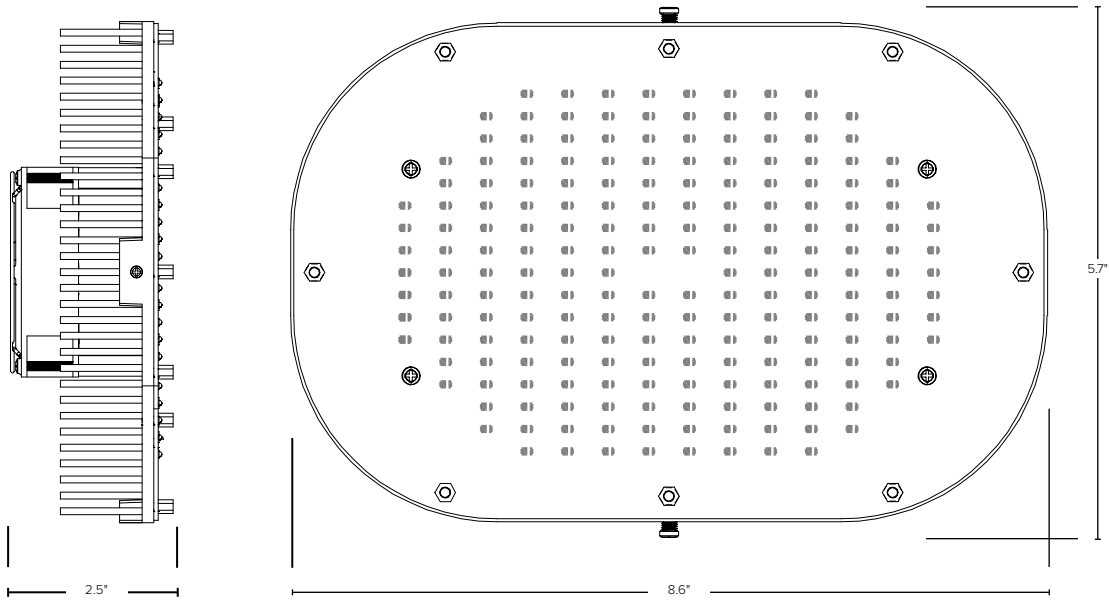

ESL-MUR-280W, 350W

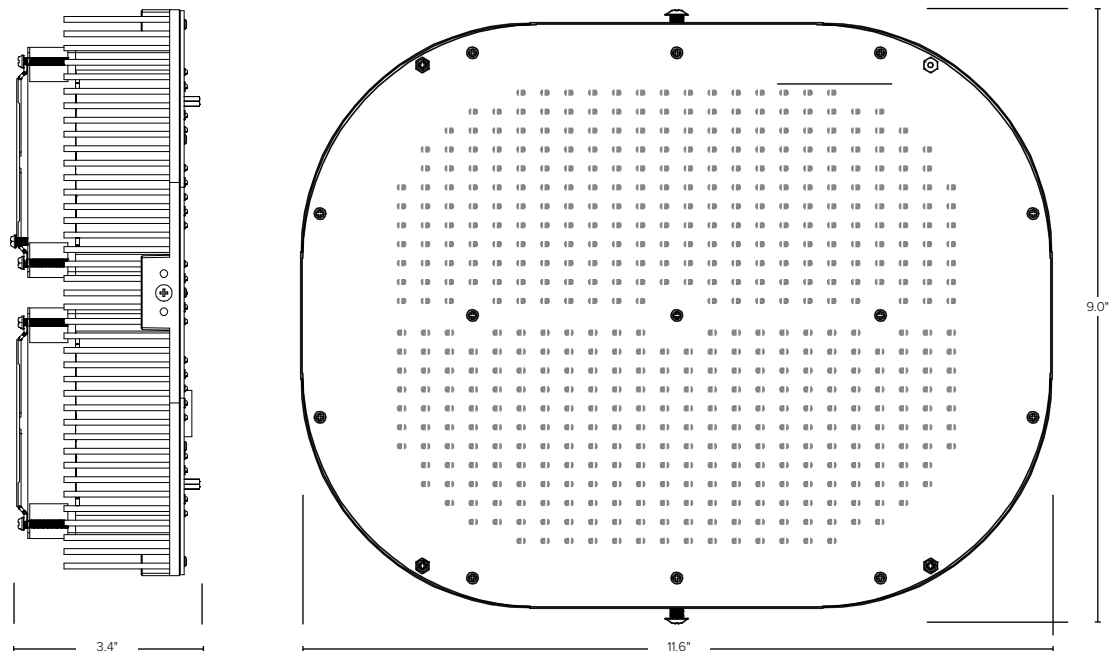

Standard Driver Dimensions:

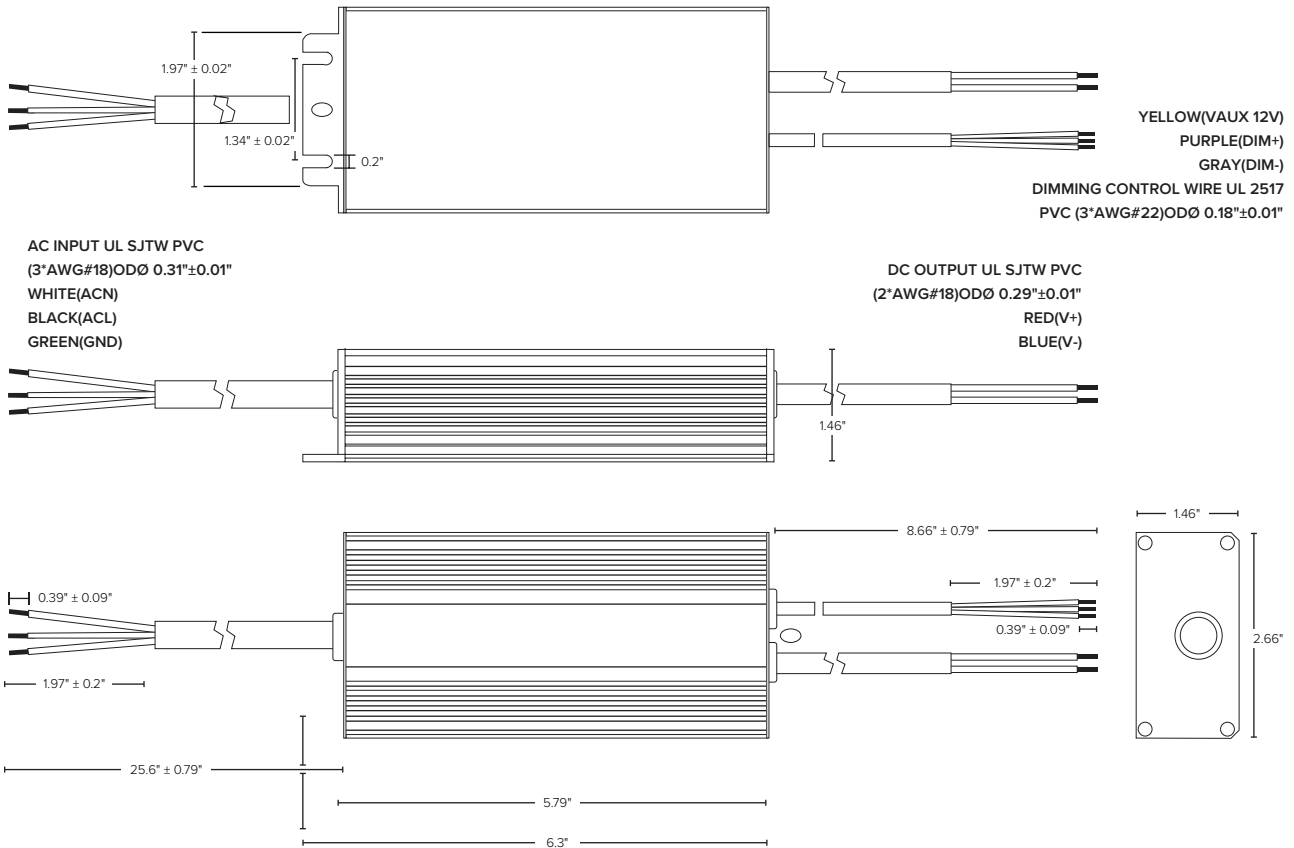

High Voltage Driver Dimensions:

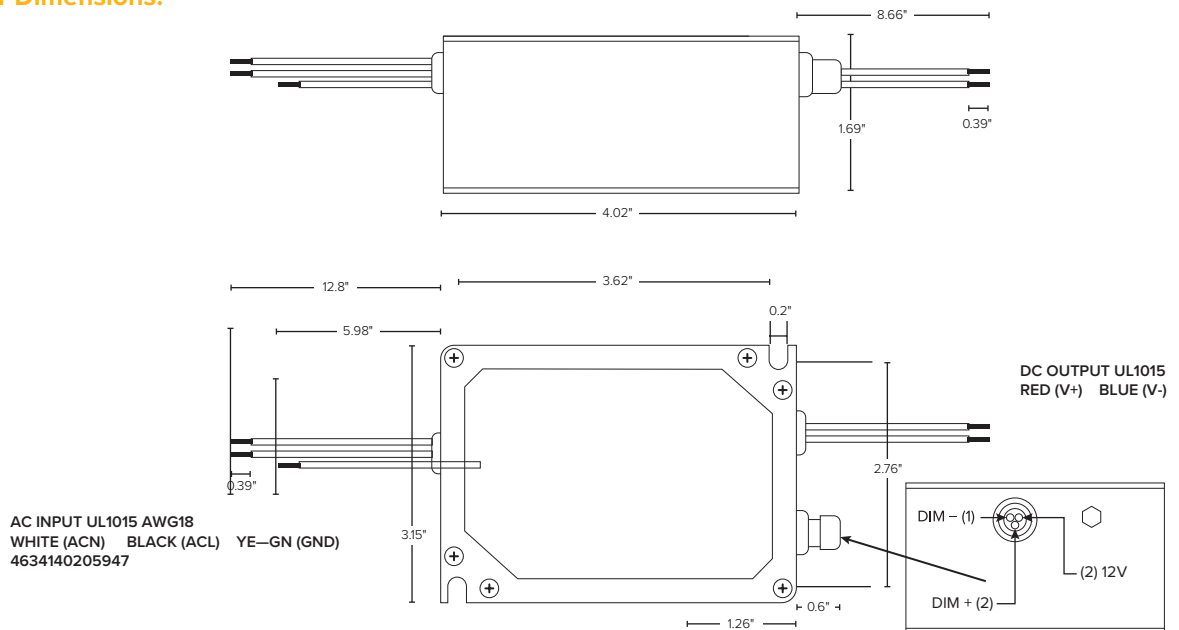

What's Included:

- (1) LED MUR
- (1) LED Outdoor Driver
- Assembled Mounting Hardware
 - U-Bracket
 - L-Bracket
- Additional Mounting Hardware
 - Hanger Block
 - L-Plate
 - Small Plate
 - Large Plate

U-Bracket

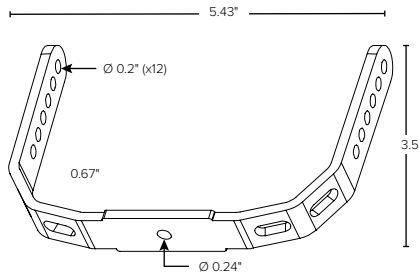

L-Bracket

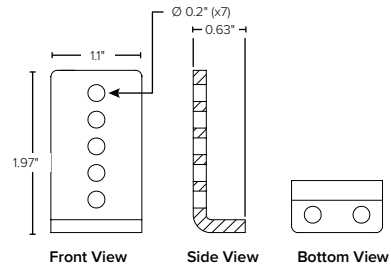

Hanger Block

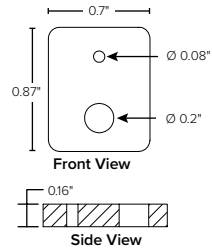

L-Plate

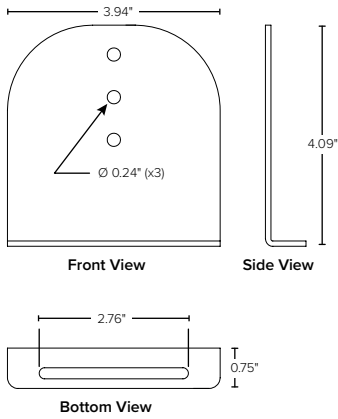

Small Plate

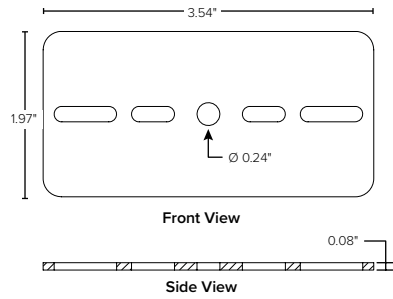

Large Plate

