



LED 1'x8' RETROFIT KIT SERIES



Ti - K18 - 36 Watts

PAGE 1 OF 2

Key Features & Benefits:

- Installs in Minutes
 - Magnetic Clips
 - Hex Tek Screws
- 16 Available Kits in 1x8 Retrofit
 - 36 Available Kits in 1x4 Retrofit
 - 54 Available Kits in 2x4 Retrofit
 - 24 Available Kits in 2x2 Retrofit
- 3,810 to 9,432 Total Kit Lumens
- Long Life 80,000 Hours (L70)
 - 10 year warranty (12 hour run times)
 - 7 year warranty (24 hour run times)



Project: _____

Date: _____

Catalog #: _____

Notes: _____



Technical Data:

Light Specifications:

Total Kit Lumens: Up to 4,535 Lumens
 Total Efficacy (lm/W): Up to 130 Lumens per Watt
 Kelvin: 3000K, 3500K, 4000K, 5000K
 Color Rendering Index (CRI): >82
 Rated Life: > 80,000 hrs

Driver Data:

Input Voltage: 120-277 VAC
 Driver Output: Single Output
 Output Power: 36 Watts
 Input Current @ 120V: 0.3 Amps
 Input Current @ 240V: 0.15 Amps
 Input Current @ 277V: 0.13 Amps
 Total Harmonic Distortion (THD): <10%
 Operating Temperature: -4 ~ 122°F
 Dimming: 1-10v Dimmable

Catalog Data:

ITEM#	WATTS	TOTAL KIT LUMENS	TOTAL EFFICACY (lm/W)	KELVIN
ESL-Ti-K18-S-36W-1L-F30	36W	4,353	125	3000K
ESL-Ti-K18-S-36W-1L-F35	36W	4,399	126	3500K
ESL-Ti-K18-S-36W-1L-F40	36W	4,444	127	4000K
ESL-Ti-K18-S-36W-1L-F50	36W	4,535	130	5000K

Ordering Guide:

ESL	-	Ti	-	K18	-	S	-	36W	-	1L	-	F	
ESL		TYPE		SERIES		CLASS		WATTS		Ti		LENS	KELVIN
		Ti Series		K18 (1x8 Kit)		S		30W (30 Watts) 36W (36 Watts)		1L (One Ti)		F (Frosted)	30 (3000 Kelvin) 35 (3500 Kelvin) 40 (4000 Kelvin) 50 (5000 Kelvin)

Alternate 1'x8' Ti Kit Options:



2L Output

What's Included:

- (1) LED Ti Bars
- (1) LED Driver
- (3) Ti Clips with Rare Earth Magnets
- (6) Self Tapping Screws
- (1) UL1598C Certification Label

Dimensions:

Ti:

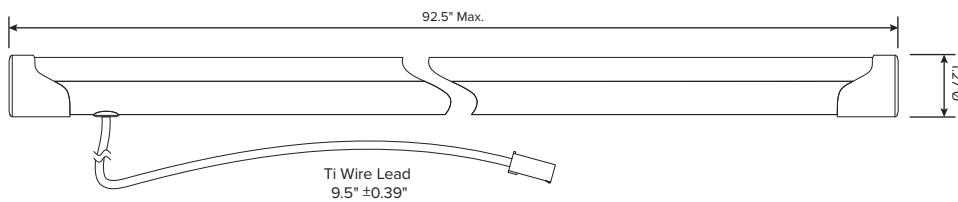

Clip:

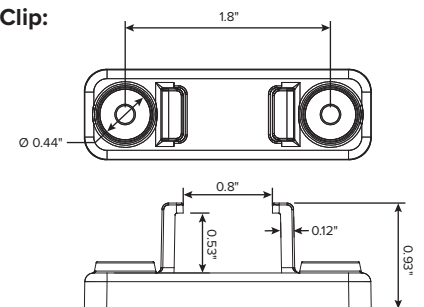

Driver:

