



LED 2'x2' RETROFIT KIT SERIES



Ti - K22 - 52 Watts

PAGE 1 OF 2

Key Features & Benefits:

- DLC Listed 2x2 Troffer Retrofit Kit
- Installs in Minutes
 - Magnetic Clips
 - Hex Tek Screws
- 24 Available 2x2 Retrofit Kits
 - 36 Available 1x4 Retrofit Kits
 - 54 Available 2x4 Retrofit Kits
- 1,829 to 5,332 Troffer Kit Lumens
- 2,360 to 6,552 Linear Ambient Kit Lumens
- Long Life 80,000 Hours (L70)
 - 10 year warranty (12 hour run times)
 - 7 year warranty (24 hour run times)



Project: _____

Date: _____

Catalog #: _____

Notes: _____

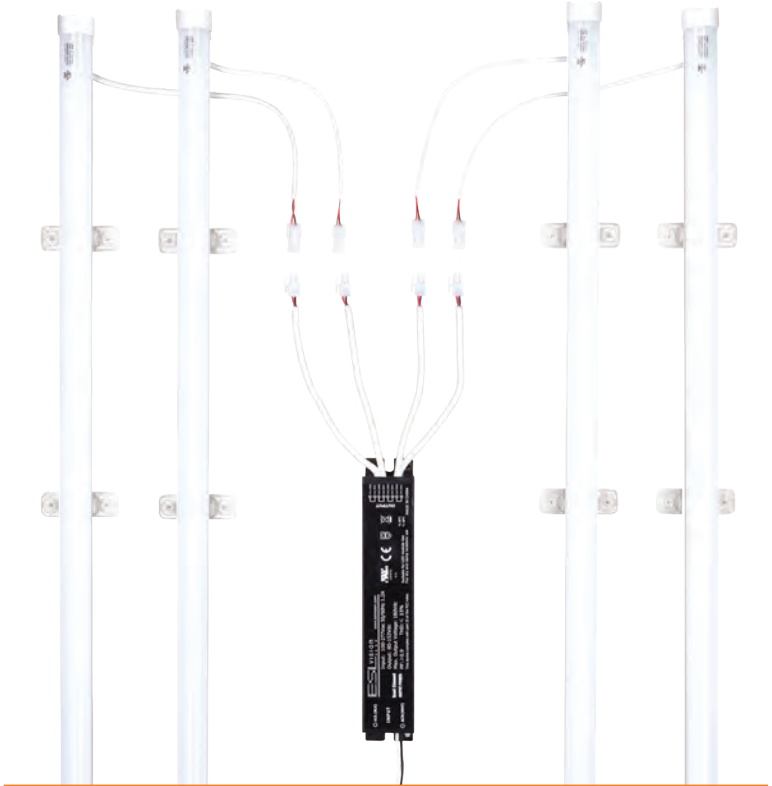

Technical Data:

Light Specifications:

Linear Ambient Kit Lumens: Up to 6,552 Lumens
 Linear Ambient Kit Efficacy (lm/W): Up to 126 Lumens per Watt
 Troffer Kit Lumens: Up to 5,332 Lumens
 Troffer Kit Efficacy (lm/W): Up to 108 Lumens per Watt
 Kelvin: 3000K, 3500K, 4000K, 5000K
 Color Rendering Index (CRI): >82
 Rated Life: > 80,000 hrs

Driver Data:

Input Voltage: 120-277 VAC
 Driver Output: Quad Output
 Output Power: 52 Watts
 Input Current @ 120V: 0.43 Amps
 Input Current @ 240V: 0.216 Amps
 Input Current @ 277V: 0.187 Amps
 Total Harmonic Distortion (THD): <10%
 Operating Temperature: -4 ~ 122°F



Catalog Data:

ITEM#	WATTS	KELVIN	TROFFER KIT LUMENS	TROFFER KIT EFFICACY (lm/W)	LINEAR AMBIENT KIT LUMENS	LINEAR AMBIENT KIT EFFICACY (lm/W)
ESL-Ti-K22-S-52W-4L-F30	52W	3000K	5,114	105	6,396	123
ESL-Ti-K22-S-52W-4L-F35	52W	3500K	5,168	105	6,396	123
ESL-Ti-K22-S-52W-4L-F40	52W	4000K	5,223	106	6,448	124
ESL-Ti-K22-S-52W-4L-F50	52W	5000K	5,332	108	6,552	126

Ordering Guide:

ESL	Ti	K22	S	52W	4L	F		
ESL	TYPE	SERIES	CLASS	WATTS	Ti	LENS	KELVIN	OPTIONS
	Ti Series	K22 (2x2 Kit)	S	40W (40 Watts) 52W (52 Watts)	4L (Four Ti)	F (Frosted)	30 (3000 Kelvin) 35 (3500 Kelvin) 40 (4000 Kelvin) 50 (5000 Kelvin)	

Alternate 2'x2' Ti Kit Options:



2L Output

3L Output

What's Included:

- (4) LED Ti Bars
- (1) LED Driver
- (8) Ti Clips with Rare Earth Magnets
- (16) Self Tapping Screws
- (1) UL1598C Certification Label

Options (Add as Suffix):

- ESL-EMG-4DC-9W (Emergency Back Up, DC, 9 Watt)

Dimensions:

Ti:

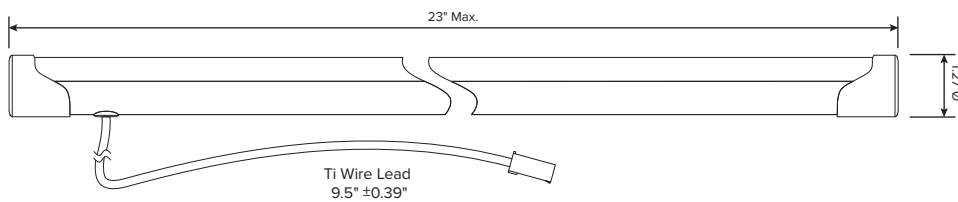

Clip:

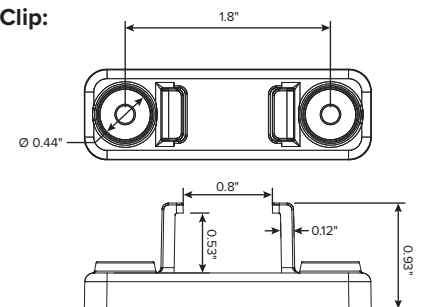

Driver:

