



LED 2'x4' RETROFIT KIT SERIES



Ti - K24 - 54 Watts

PAGE 1 OF 2

Key Features & Benefits:

- DLC Listed 2x4 Troffer Retrofit Kit
- Installs in Minutes
 - Magnetic Clips
 - Hex Tek Screws
- 54 Available 2x4 Retrofit Kits
 - 24 Available 2x2 Retrofit Kits
 - 36 Available 1x4 Retrofit Kits
- 2,779 to 12,639 Troffer Kit Lumens
- 3,328 to 14,280 Linear Ambient Kit Lumens
- Long Life 80,000 Hours (L70)
 - 10 year warranty (12 hour run times)
 - 7 year warranty (24 hour run times)



Project: _____

Date: _____

Catalog #: _____

Notes: _____

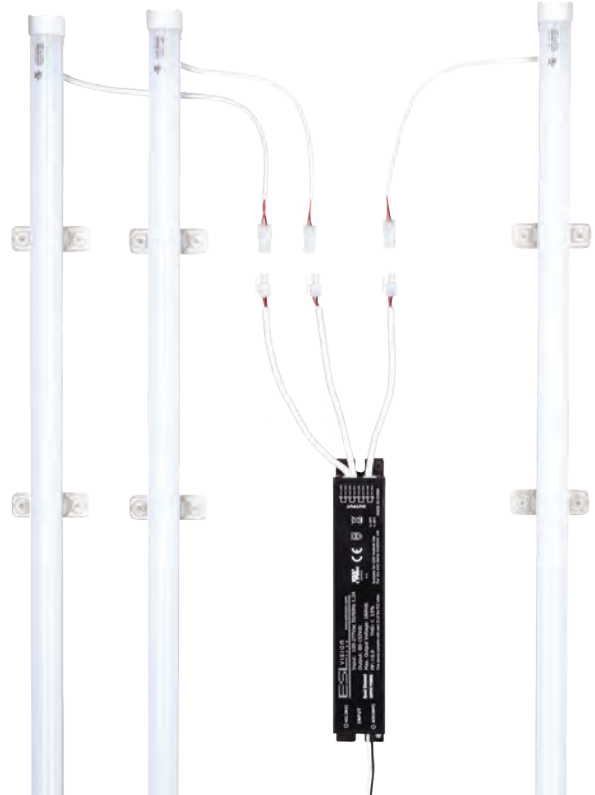

Technical Data:

Light Specifications:

Linear Ambient Kit Lumens: Up to 7,128 Lumens
 Linear Ambient Kit Efficacy (lm/W): Up to 132 Lumens per Watt
 Troffer Kit Lumens: Up to 5,542 Lumens
 Troffer Kit Efficacy (lm/W): Up to 110 Lumens per Watt
 Kelvin: 3000K, 3500K, 4000K, 5000K
 Color Rendering Index (CRI): >82
 Rated Life: > 80,000 hrs

Driver Data:

Input Voltage: 120-277 VAC
 Driver Output: Triple Output
 Output Power: 54 Watts
 Input Current @ 120V: 0.45 Amps
 Input Current @ 240V: 0.225 Amps
 Input Current @ 277V: 0.195 Amps
 Total Harmonic Distortion (THD): <10%
 Operating Temperature: -4 ~ 122°F



Catalog Data:

ITEM#	WATTS	KELVIN	TROFFER KIT LUMENS	TROFFER KIT EFFICACY (lm/W)	LINEAR AMBIENT KIT LUMENS	LINEAR AMBIENT KIT EFFICACY (lm/W)
ESL-Ti-K24-S-54W-3L-F30	54W	3000K	5,409	107	6,912	128
ESL-Ti-K24-S-54W-3L-F35	54W	3500K	5,453	108	6,966	129
ESL-Ti-K24-S-54W-3L-F40	54W	4000K	5,498	109	7,020	130
ESL-Ti-K24-S-54W-3L-F50	54W	5000K	5,542	110	7,128	132

Ordering Guide:

ESL	Ti	K24	S	54W	3L	F		
ESL	TYPE	SERIES	CLASS	WATTS	Ti	LENS	KELVIN	OPTIONS
ESL	Ti Series	K24 (2x4 Kit)	S	39W (39 Watts) 45W (45 Watts) 54W (54 Watts) 66W (66 Watts)	3L (Three Ti)	F (Frosted)	30 (3000 Kelvin) 35 (3500 Kelvin) 40 (4000 Kelvin) 50 (5000 Kelvin)	

Alternate 2'x4' Ti Kit Options:



2L Output

4L Output

What's Included:

- (3) LED Ti Bars
- (1) LED Driver
- (6) Ti Clips with Rare Earth Magnets
- (12) Self Tapping Screws
- (1) UL1598C Certification Label

Options (Add as Suffix):

- ESL-EMG-4DC-9W (Emergency Back Up, DC, 9 Watt)

Dimensions:

Ti:

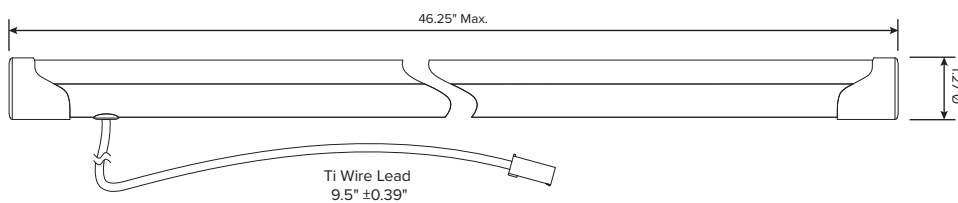

Clip:

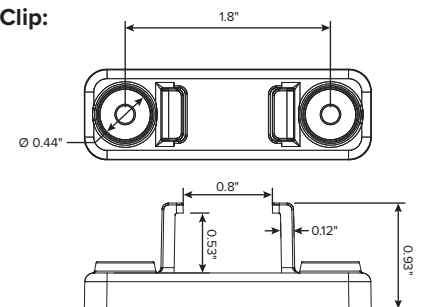

Driver:

