

### Key Features & Benefits:

- Installs in Minutes
  - Magnetic Clips
  - Hex Tek Screws
- 16 Available Kits in 1x2 Retrofit
  - 36 Available Kits in 1x4 Retrofit
  - 54 Available Kits in 2x4 Retrofit
  - 24 Available Kits in 2x2 Retrofit
  - 16 Available Kits in 1x8 Retrofit
- 1,180 to 8,064 Total Kit Lumens
- Long Life 80,000 Hours (L70)
  - 10 year warranty (12 hour run times)
  - 7 year warranty (24 hour run times)

Project: \_\_\_\_\_

Date: \_\_\_\_\_

Catalog #: \_\_\_\_\_

Notes: \_\_\_\_\_



### Technical Data:

#### Light Specifications:

Total Kit Lumens: Up to 1,586 Lumens  
 Total Efficacy (lm/W): Up to 124 Lumens per Watt  
 Kelvin: 3000K, 3500K, 4000K, 5000K  
 Color Rendering Index (CRI): >82  
 Rated Life: > 80,000 hrs

#### Driver Data:

Input Voltage: 120-277 VAC  
 Driver Output: Single Output  
 Output Power: 13 Watts  
 Input Current @ 120V: 0.108 Amps  
 Input Current @ 240V: 0.054 Amps  
 Input Current @ 277V: 0.047 Amps  
 Total Harmonic Distortion (THD): <10%  
 Operating Temperature: -4 ~ 122°F

### Catalog Data:

ITEM#	WATTS	TOTAL KIT LUMENS	TOTAL EFFICACY (lm/W)	KELVIN
ESL-Ti-K12-S-13W-1L-F30	13W	1,547	118	3000K
ESL-Ti-K12-S-13W-1L-F35	13W	1,547	118	3500K
ESL-Ti-K12-S-13W-1L-F40	13W	1,560	120	4000K
ESL-Ti-K12-S-13W-1L-F50	13W	1,586	124	5000K

### Ordering Guide:

<b>ESL</b>	<b>Ti</b>	<b>K12</b>	<b>S</b>	<b>13W</b>	<b>1L</b>	<b>F</b>	
ESL	TYPE	SERIES	CLASS	WATTS	Ti	LENS	KELVIN
	Ti Series	K12 (1x2 Kit)	S	10W (10 Watts) 13W (13 Watts)	1L (One Ti)	F (Frosted)	30 (3000 Kelvin) 35 (3500 Kelvin) 40 (4000 Kelvin) 50 (5000 Kelvin)

### Alternate 1'x2' Ti Kit Options:



2L Output

### What's Included:

- (1) LED Ti Bars
- (1) LED Driver
- (2) Ti Clips with Rare Earth Magnets
- (4) Self Tapping Screws
- (1) UL1598C Certification Label

### Dimensions:

#### Ti:

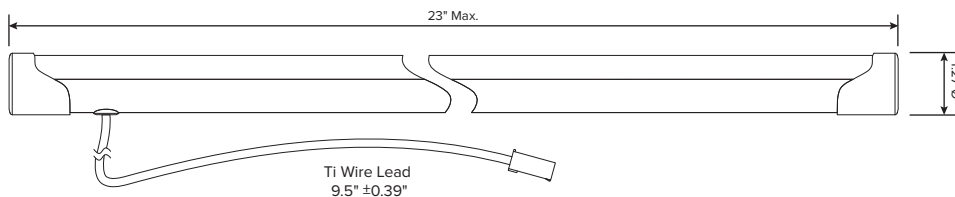

#### Clip:

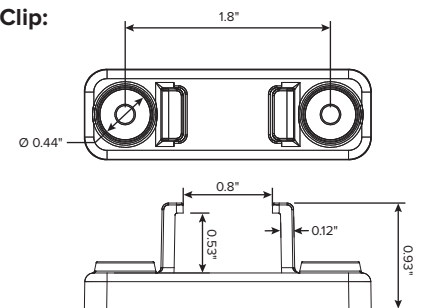

#### Driver:

