



LED VAPOR RETROFIT KIT SERIES



Ti - VP8RK - 44 Watts

PAGE 1 OF 5

Product Description:

Premium grade LED retrofit for existing fluorescent vapor tight fixtures. Upgrade existing vapor tight fixtures to LED in under 5 minutes.



Project: _____ Date: _____

Catalog #: _____

Notes: _____

Key Features & Benefits:

- Single Piece Design
- 0-10v Dimming Driver with 12v Aux
- 7 Year Warranty
- Frosted Ti Bars Enables Use of Existing Clear Lens
- Control Options
 - Photocell
 - Occupancy
- Emergency Capable

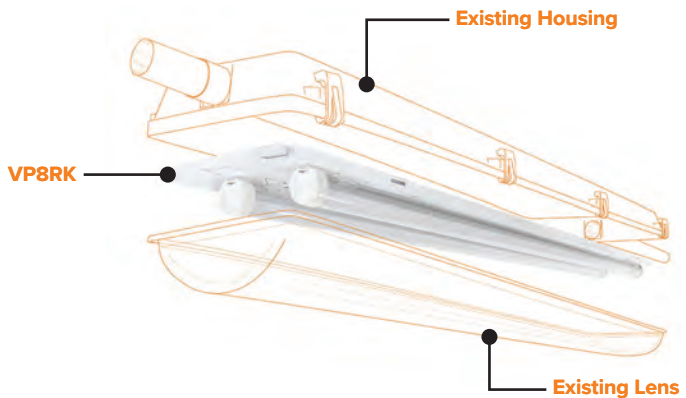

Performance Summary:

Wattage: 44
 Lumens: Up to 5,810 Lumens
 Efficacy: Up to 133 Lumens per Watt
 Kelvin: 3000K, 3500K, 4000K, 5000K
 Color Rendering Index (CRI): >82
 Rated Life: > 80,000 hrs

8' (VP8RK) Fixture Retrofit Compatibility:

- Columbia XEM & HEM Series
- LSI EG3 Series
- HE Williams 96 Series
- Simkar ENZ Series
- Texas Fluorescents CIT Series
- Atlas IFW Series
- LDPI 376 Series
- Daybrite DW Series
- Contact factory for custom configurations

Ordering Guide:

ESL	-	Ti	-	VP8RK	-	S	-	44W	-	F	
ESL		TYPE		SERIES		PERFORMANCE		WATTS		Ti LENS	KELVIN
		Ti Series TiHO Series		VP8RK (8ft Vapor Retrofit)		S (Standard) P (Premium)		36W (36 Watts) 44W (44 Watts) 60W (60 Watts) 88W (88 Watts) 120W (120 Watts) 180W (180 Watts)		F (Frosted)	30 (3000 Kelvin) 35 (3500 Kelvin) 40 (4000 Kelvin) 50 (5000 Kelvin)

Accessories (Field Installed)

Sensors:
ESL-REM-100 (Hand Held Remote to Control ESL-4OCC-LDD)
Lens:
ESL-VP8-LENS-SHPC-CL (Shallow Lens Polycarbonate Clear)
ESL-VP8-LENS-SHPC-FR (Shallow Lens Polycarbonate Frosted)
ESL-VP8-LENS-SHAC-CL (Shallow Lens Acrylic Clear)
ESL-VP8-LENS-SHAC-FR (Shallow Lens Acrylic Frosted)

*Not all lenses are stocked items. Alternative lens options available. Please contact factory for more information.

Options (Factory Installed)

Emergency BBU:
ESL-EMG-SL1-OTB-9W (9 Watts Output, 90Min, 120-277VAC Input, 10-300VDC Output, Open Terminal Block Wiring)
ESL-EMG-SL2-CLW-5W (5 Watts Output, 90Min, 120-277VAC Input, 20-250VDC Output, Closed Lead Wiring)
ESL-EMG-SL3-CLW-5W (5 Watts Output, 90Min, 120-277VAC Input, 20-50VDC Output, Closed Lead Wiring)
ESL-EMG-SL1-CDC-18W (18W Output, 90Min, 120-277VAC Input, 20-300VDC Output, Closed Frame with Dual Flex Conduits)
Sensors:
ESL-3OCC (IP65 0-10v Occupancy Dimming Sensor. 8'- 50' Mounting, Wire From Side)
ESL-3OCCB (IP65 0-10v Occupancy Dimming Sensor. 8'- 50' Mounting, Wire From Top)

Options & Accessories:



ESL-30CC / ESL-30CCB

Sensor Type: Microwave

Sensitivity Adjustment: 20% / 50% / 75% / 100%

Dimming Control Output: 0-10V Max. 25mA sinking current

Detection Radius/angle: 26.2ft@50ft Height/360°

Detection Area (square footage): 2155ft²@50ft Height/360°

Mounting Height: 50ft Max

Remote Range: 50ft

For more information please see the
ESL-30CC cut sheet



ESL-REM-100



ESL-EMG-SL1-OTB-9W

ESL-EMG-SL2-CLW-5W

ESL-EMG-SL3-CLW-5W

ESL-EMG-SL1-CDC-18W

For more information please see the
ESL-EMG-SL1-OTB-9W cut sheet
ESL-EMG-SL2-CLW-5W cut sheet
ESL-EMG-SL3-CLW-5W cut sheet
ESL-EMG-SL1-CDC-18W cut sheet

VP4RK - Catalog Data:

ESL	TYPE	SIZE	WATTAGE	FROSTED	KELVIN		KELVIN		KELVIN		KELVIN	
					3000K (30)		3500K (35)		4000K (40)		5000K (50)	
					LUMENS	LPW	LUMENS	LPW	LUMENS	LPW	LUMENS	LPW
ESL-Ti-VP4RK-S-26W-F					3,620	139	3,665	141	3,720	143	3,750	144
ESL-Ti-VP4RK-S-36W-F					4,645	129	4,610	128	4,570	127	4,550	126
ESL-Ti-VP4RK-S-44W-F					6,070	138	6,200	141	6,350	144	6,450	144
ESL-TiHO-VP4RK-P-60W-F					N/A	N/A	N/A	N/A	8,020	133	8,165	136

VP8RK - Catalog Data:

ESL	TYPE	SIZE	WATTAGE	FROSTED	KELVIN		KELVIN		KELVIN		KELVIN	
					3000K (30)		3500K (35)		4000K (40)		5000K (50)	
					LUMENS	LPW	LUMENS	LPW	LUMENS	LPW	LUMENS	LPW
ESL-Ti-VP8RK-S-36W-F					4,595	127	4,610	128	4,645	129	4,680	130
ESL-Ti-VP8RK-S-44W-F					5,725	130	5,765	131	5,810	132	5,650	133
ESL-Ti-VP8RK-S-60W-F					7,785	130	7,860	131	7,920	132	7,980	133
ESL-Ti-VP8RK-S-88W-F					10,950	124	11,000	125	11,090	126	11,175	127
ESL-TiHO-VP8RK-P-120W-F					N/A	N/A	N/A	N/A	15,750	131	15,600	130
ESL-TiHO-VP8RK-P-180W-F					N/A	N/A	N/A	N/A	23,800	132	24,300	135

VPHBRK - Catalog Data:

ESL	TYPE	SIZE	WATTAGE	FROSTED	KELVIN		KELVIN	
					4000K (40)		5000K (50)	
					LUMENS	LPW	LUMENS	LPW
ESL-TiHO-VPHBRK-P-60W-F					9,013	150	9,216	154
ESL-TiHO-VPHBRK-P-90W-F					13,525	150	13,765	155
ESL-TiHO-VPHBRK-P-120W-F					17,876	150	18,125	151
ESL-TiHO-VPHBRK-P-150W-F					22,821	152	23,019	151
ESL-TiHO-VPHBRK-P-180W-F					27,128	151	27,320	152

4' (VP4RK) & 8' (VP8RK) Fixture Retrofit Compatibility:

- Columbia XEM & HEM Series
- LSI EG3 Series
- HE Williams 96 Series
- Simkar ENZ Series
- Texas Fluorescents CIT Series
- Atlas IFW Series
- LDPI 376 Series
- Daybrite DW Series
- Contact factory for custom configurations

High Bay (VPHBRK) Fixture Retrofit Compatibility:

- ILP Blizzard Series
- Lithonia FHE Series
- Cooper VT4 Series
- Columbia XEW4 Series
- Philips DayBrite CFI Series

4' & 8' Installation:

Included Parts:

- (1) Ti LED Retrofit Plate
- (2) Vapor Retrofit Brackets
- (2) Retrofit Bracket Screws

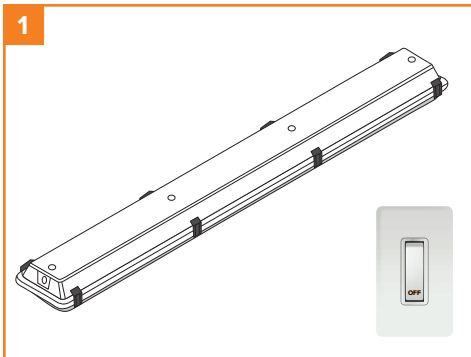
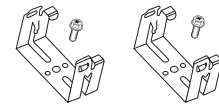

1 Disconnect power to the fixture

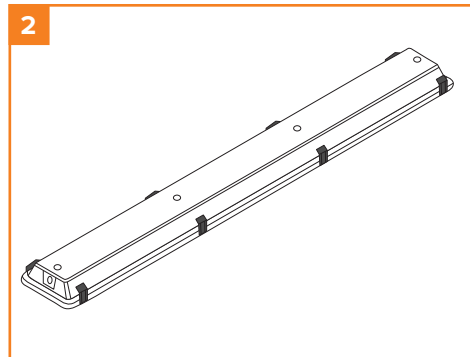

2 Unhinge latches to remove lens

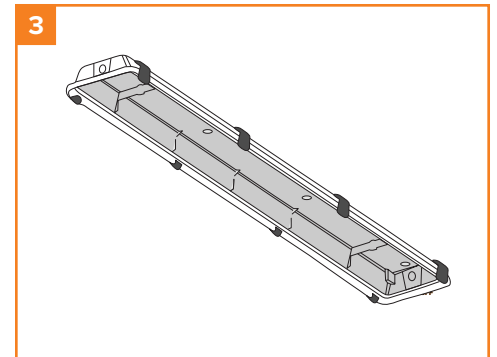

3 Disconnect ballast and remove existing gear tray from fixture. If ballast is not installed on gear tray, remove from housing.

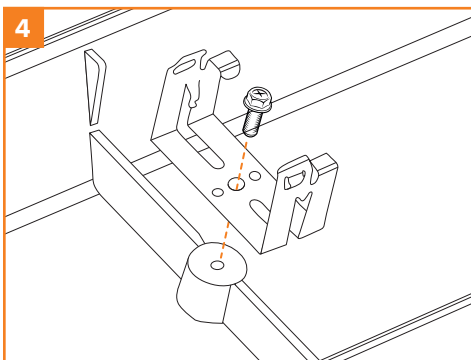

4 Install provided retrofit brackets into the housing. Remove existing clips if needed. If there are no clips, please confirm that housing has socket bars before continuing installation.

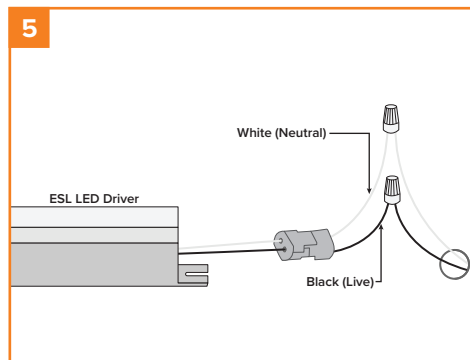

5 Connect AC input lines to incoming AC power using the proper connectors in accordance with current state and federal regulations.

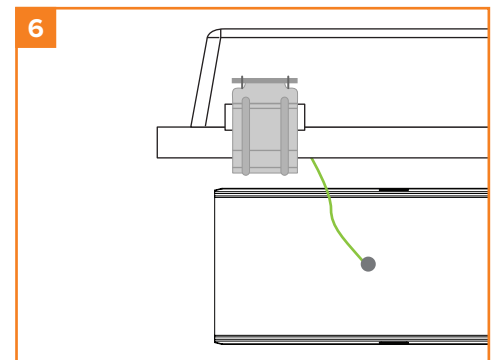

6 Ground the retrofit kit.

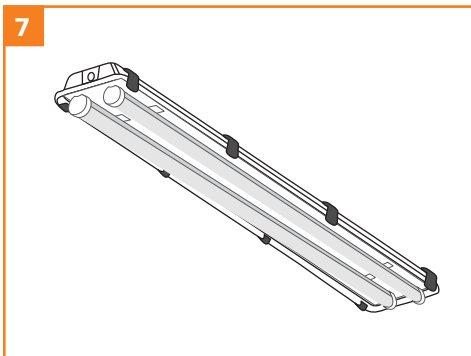

7 Once all electrical connections are made, push the retrofit plate up into the retrofit brackets to secure plate to body. If brackets were not used, use Tek-screws to attach plate to socket bars.

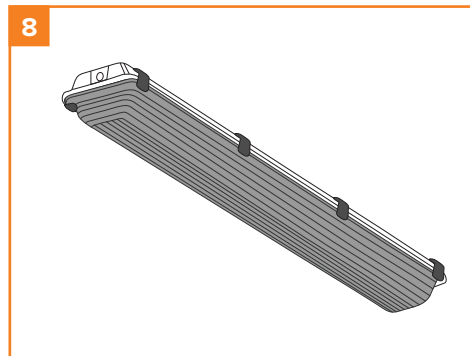

8 Reattach the lens to the fixture body.

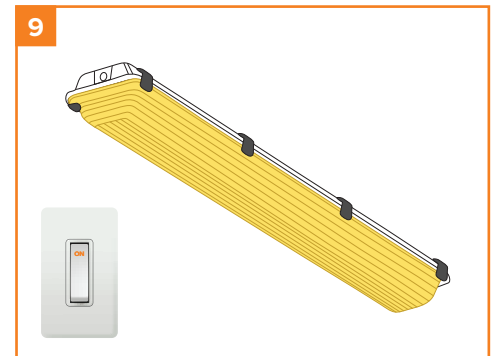

9 Restore power to the fixture to complete installation.

Product Specifications:

Construction:

- Single piece design with pre-punched holes allowing for quick and easy installation
- Die-formed and embossed code 22 gauge steel
- High reflectance, baked white enamel finish

Electrical:

- Input Voltage: 120-277 VAC
- Power Factor @120 VAC - 0.97%, @277 VAC - 0.90%
- THD @110 VAC <10%, @277 VAC <15%
- Operating Temperature: -4°F to 122°F (-20°C to 50°C)
- CRI: >82
- Lifespan: >80,000 Hours
- Dimming: 0-10V Dimmable

Dimensions:

VP4RK SERIES

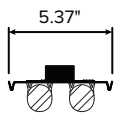

Side View

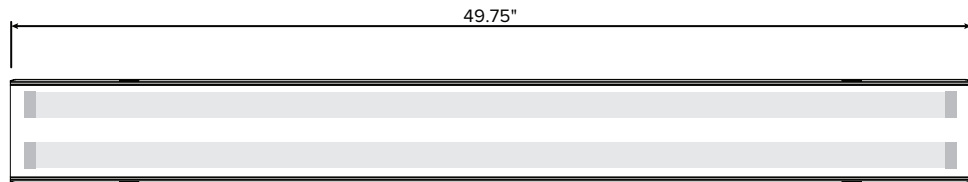

Front View

VP8RK SERIES

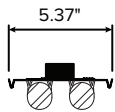

Side View

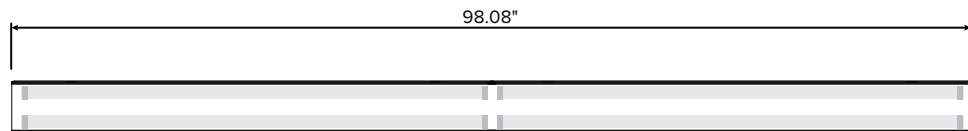

Front View

VPHBRK SERIES

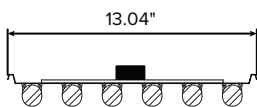

Side View

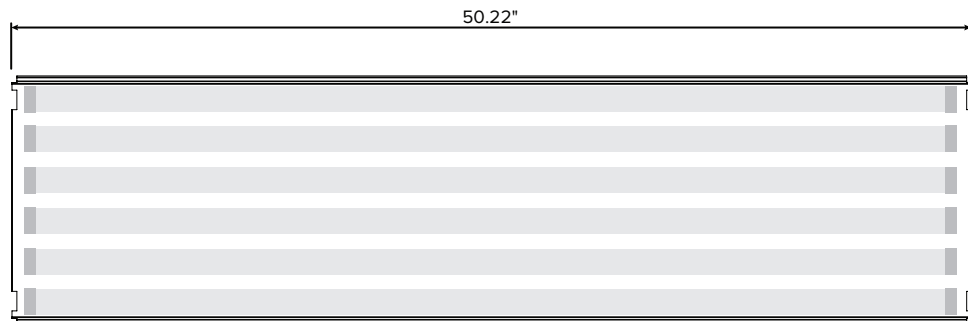

Front View



LED VAPOR RETROFIT KIT SERIES



Technical Data

Lumen Ambient Temperature (LAT) Multipliers:

AMBIENT		LUMEN MULTIPLIER
0 °C	32 °F	1.02
10 °C	50 °F	1.01
20 °C	68 °F	1
25 °C	77 °F	1
30 °C	86 °F	1
40 °C	104 °F	0.99
50 °C	122 °F	0.96

LED Lumen Maintenance:

SYSTEM WATTS	HOURS			
	0	25000	50000	100000
VP4RK				
26	-	-	-	-
36				
44				
60				
VP8RK				
36	-	-	-	-
44				
60				
88				
120				
180				
VPHBRK				
60	-	-	-	-
90				
120				
150				
180				

VP4RK - Electrical Load:

SYSTEM WATTS	INPUT CURRENT				INPUT VOLTAGE	INPUT FREQUENCY	POWER FACTOR	THD	OPERATING TEMPERATURE	DIMMING
	120 VAC	208 VAC	240 VAC	277 VAC						
26	0.22	0.13	0.11	0.09	120-277 VAC	50/60 Hz	>0.97 @120 VAC >0.90 @277 VAC	<10% @110VAC <15% @277VAC	-4°F to 122°F (-20°C to 50°C)	0-10V
36	0.30	0.17	0.15	0.13						
44	0.37	0.21	0.18	0.16						
60	0.50	0.29	0.25	0.22						

VP8RK - Electrical Load:

SYSTEM WATTS	INPUT CURRENT				INPUT VOLTAGE	INPUT FREQUENCY	POWER FACTOR	THD	OPERATING TEMPERATURE	DIMMING
	120 VAC	208 VAC	240 VAC	277 VAC						
36	0.30	0.17	0.15	0.13	120-277 VAC	50/60 Hz	>0.97 @120 VAC >0.90 @277 VAC	<10% @110VAC <15% @277VAC	-4°F to 122°F (-20°C to 50°C)	0-10V
44	0.37	0.21	0.18	0.16						
60	0.50	0.29	0.25	0.22						
88	0.73	0.42	0.37	0.32						
120	1.00	0.58	0.50	0.43						
180	1.50	0.87	0.75	0.65						

VPHBRK - Electrical Load:

SYSTEM WATTS	INPUT CURRENT				INPUT VOLTAGE	INPUT FREQUENCY	POWER FACTOR	THD	OPERATING TEMPERATURE	DIMMING
	120 VAC	208 VAC	240 VAC	277 VAC						
60	0.50	0.29	0.25	0.22	120-277 VAC	50/60 Hz	>0.97 @120 VAC >0.90 @277 VAC	<10% @110VAC <15% @277VAC	-4°F to 122°F (-20°C to 50°C)	0-10V
90	0.75	0.43	0.38	0.32						
120	1.00	0.58	0.50	0.43						
150	1.25	0.72	0.63	0.54						
180	1.50	0.87	0.75	0.65						