

! WARNING

1. To avoid electric shock, disconnect power at source prior to installation.
2. The installation should be performed by qualified electricians or lighting technicians.
3. Before conducting any installation, maintenance, or removal, disable all power to the luminaires and wait until the fixture cools down.
4. Do not touch the fixture while it is in service.
5. If there is any problem with the fixture, DO turn off power and DO NOT attempt repair unless you are a qualified technician or the customer service member.
6. Please read the label information carefully to get proper input voltage for this product.
7. This luminaire is designed to operate in ambient temperatures ranging from -40°C to 45°C.
8. This product is not available for several special environments, such as places with corrosive gas liquids or high pressure water vapor.

Installation (Option 1)

1. Turn off the power

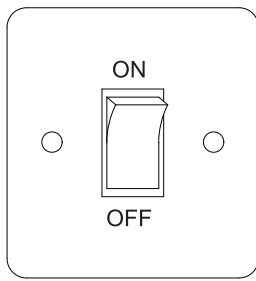

2. Loosen the 4 screws shown below

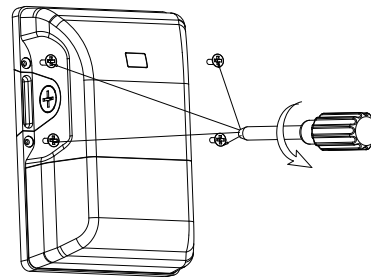

3. Remove the 1/2 end cap

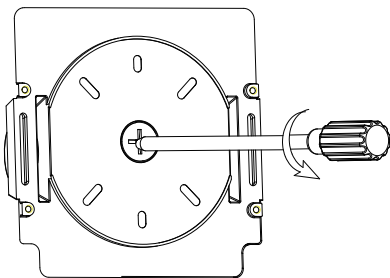

4. Peel off the yellow sticker and paste it on the round area of the bottom mounting plate

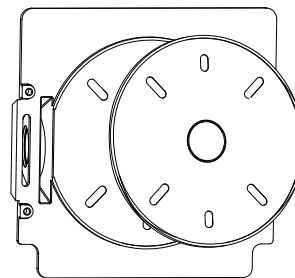

5. Fix the bottom plate on the round plate

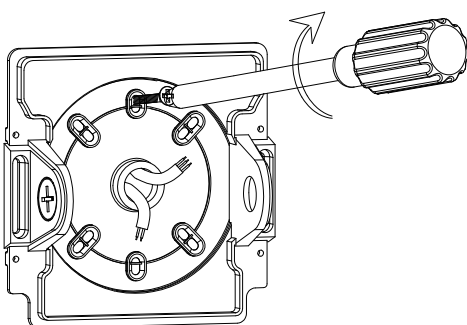

6. Make the wiring connections as shown below

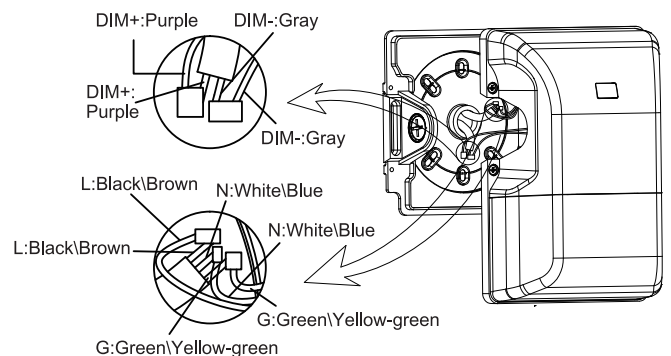

Installation (Option 1)

7. Screw the 4 screws shown below to finalize installation

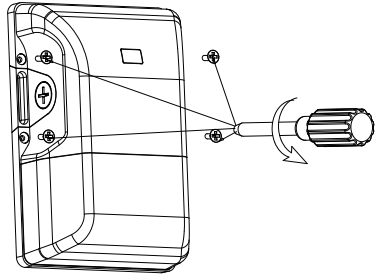

8. Restore power

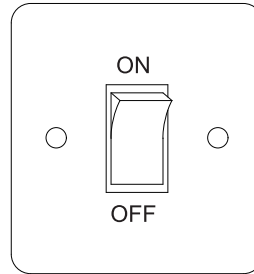

Installation (Option 2)

1. Turn off the power

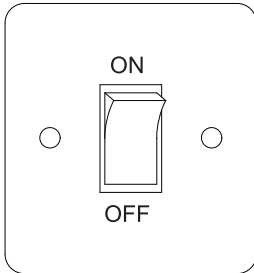

2. Loosen the 4 screws shown below

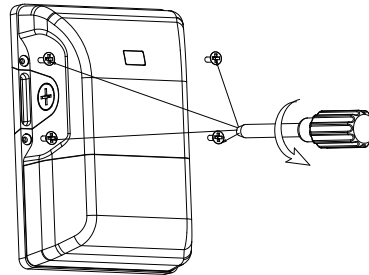

3. Paste the black sponge pad on the bottom mounting plate

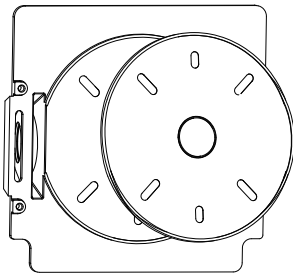

4. Screw the bottom mounting plate to the wall

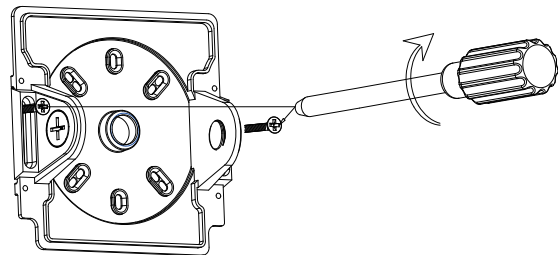

5. Remove one of the 1/2 end cap and feed wires through hole

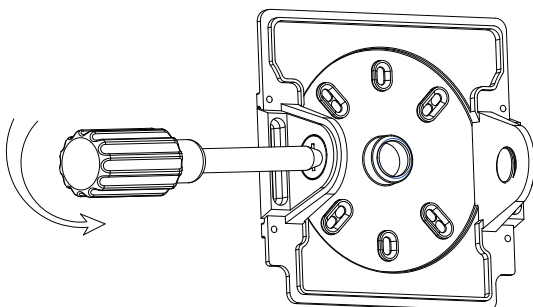

6. Make the wiring connections as shown below

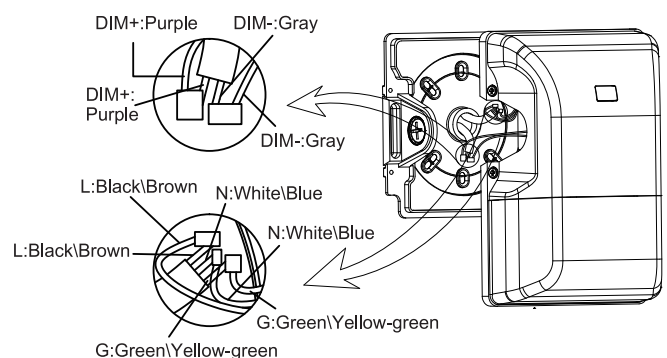

Installation (Option 2)

7. Screw the 4 screws shown below to finalize installation

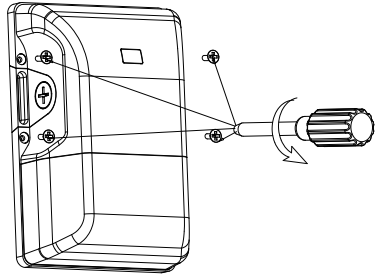

8. Restore power

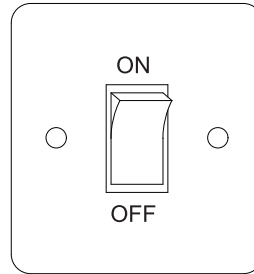

Adjustability

- The adjustable wattage dial at the top of the fixture has three positional wattage options.
- The adjustable kelvin dip switch box in the center of the fixture has three positional kelvin options.

ADJUSTABLE WATTAGE

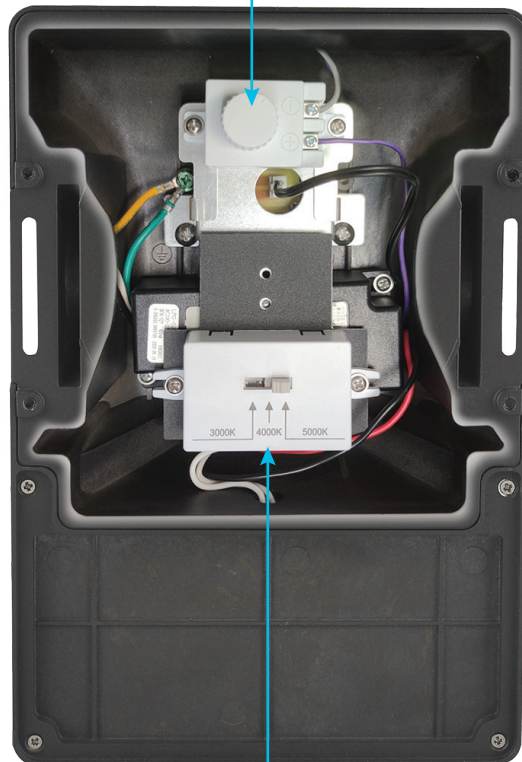

KELVIN ADJUSTABLE

