

Compatible Parts

1'X4'

MOUNT:
ESLC-DP-SMF-14-W

FIXTURES:
ESLC-DPS-14-U-P-2
ESLC-DP-14-U-P-30-xxK-80-D

2'X2'

MOUNT:
ESLC-DP-SMF-22-W





FIXTURES:
ESLC-DPS-22-U-P-2
ESLC-DP-22-U-P-yy-xxK-80-D

2'X4'

MOUNT:
ESLC-DP-SMF-24-W

FIXTURES:
ESLC-DPS-22-U-P-2
ESLC-DP-24-U-P-yy-xxK-80-D

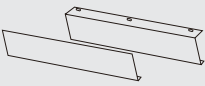
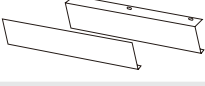
Kit Contents (Available for 1'x4', 2'x2' & 2'x4')

PART	1'x4'	2'x2'	2'x4'	DIMENSIONS	MATERIAL
Screw A 	8	8	8	ø.04" x .4"	Zinc Coated Iron
Screw B 	6	6	6	ø.16" x .98"	Zinc Coated Iron
Expansion Bolt 	6	6	6	ø.24" x 1.18"	PVC
1' Frame 	2	0	0	12.04" x 2.44"	Aluminum
2' Frame 	0	4	2	24.08" x 2.44"	Aluminum
4' Frame 	2	0	2	48.17" x 2.44"	Aluminum

Installation

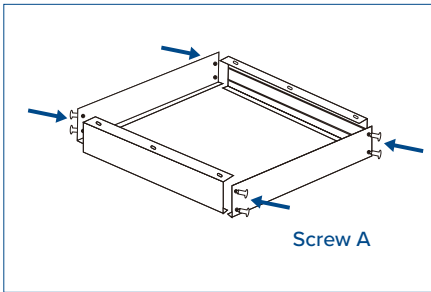

1 Assemble the four sides with **Screw A** (total of 8) to create the frame.

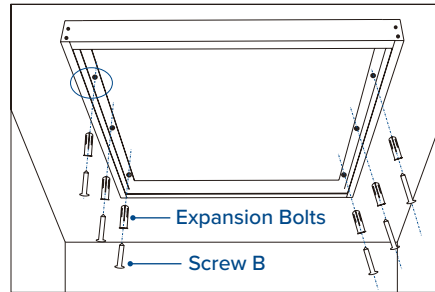

2 Fix the frame to the ceiling using **Screw B** with the **Expansion Bolts**.

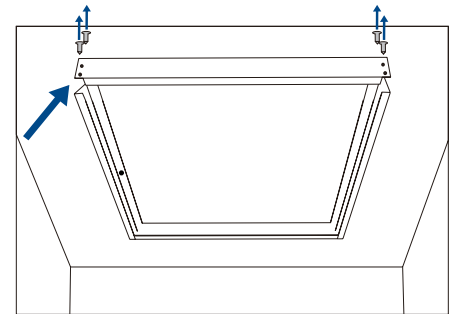

3 Once securely mounted to the ceiling, disassemble one end by removing **Screw A** (total of 4)

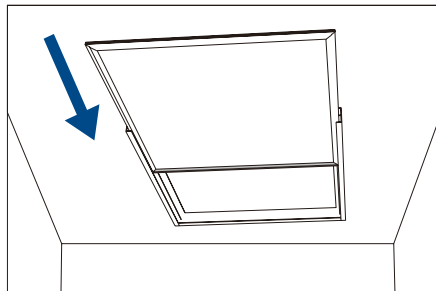

4 Slide the panel into the frame channel.

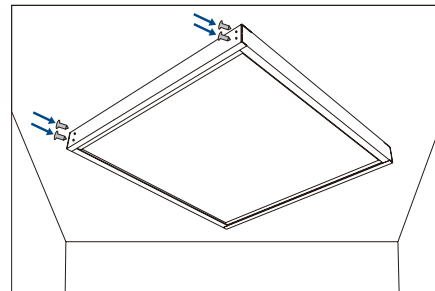

5 Reassemble the frame end with the remaining **Screw A** (total of 4).