

Product Features:

- Wattage Adjustable with No Tools Required
- Lightweight Design for Easy Installation
- DLC 5.1 Premium
- Innovative Mounting Hardware Allows for Single Person Installation
- 10kV Surge Protection Standard
- 7 Year Warranty

Project: _____

Date: _____

Catalog #: _____

Notes: _____

Product Specifications:

Electrical:

Input Voltage Options: 120–277 VAC, 277–480 VAC
 Operating Temperature: -40°F to 140°F (-40°C to 60°C)
 Life: L70 Lifetime >100,000 hours, L90 Lifetime >48,000 Hours —TM-21, @77F
 Dimming: 0–10V Dimmable
 12V Auxiliary
 10kV Surge Protection
 Wattage: 280W
 Kelvin: 4000K, 5000K

Optical:

Optical Grade Polycarbonate Lens with UV Protection
 Prismatic Molded Lens for Optimal Uniformity
 Impact Resistant Lens

Construction:

Rugged Anodized Aluminum Housing
 High Performance Heat Sink
 Weather-tight Tool-less Entry Access
 Stainless Steel Hardware



Dimensions:

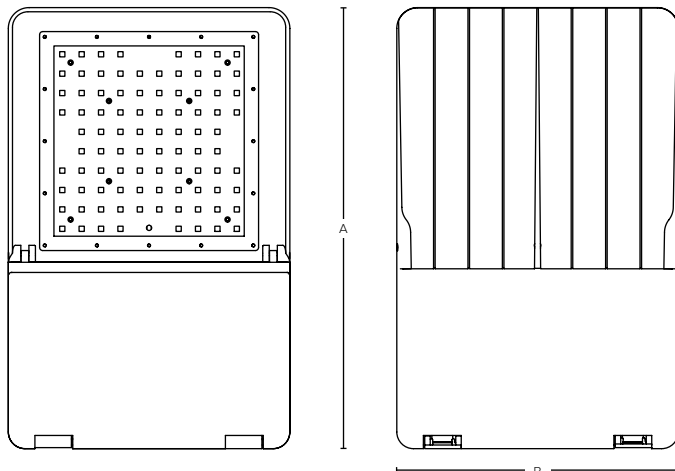

SYSTEM WATTS	DIMENSIONS			WEIGHT Pounds (lbs)
	A	B	C	
80185W	16.65"	10.63"	1.38"	10.6
200350W	20.35"	13.78"	2.56"	14.1

Ordering Guide:

ESL	TYPE	FACTORY FIXED WATTAGE	GENERATION	KELVIN	VOLTAGE	FINISH	LENS	OPTIONS
ESL	CAL (CAL) Area Light	280W 280W	1 (1) 1st Generation	(xx) (40) 4000K (50) 5000K	(zz) (blank) 120–277V (HV) 277–480V	(ff) (BZ) Bronze (WH) White	T# (T3) default (T4) (T5)	Factory Installed

Factory Installed Options

Sensors	Receptacle
8OCC Area Light Occupancy Sensor, Dip Switch, 0–10v, 12VDC Input	RPC3 3 Pin Twist Lock Receptacle

Field Installed Accessories

MOUNTS (with knuckle)	LENS
ESL-AL-BZKNDM Area Light Bronze Knuckle Direct Mount	ESL-CAL1-SLENS-T3 Contractor Area Light 80–185W T3 Lens
ESL-AL-WHKNDM Area Light White Knuckle Direct Mount	ESL-CAL1-SLENS-T4 Contractor Area Light 80–185W T4 Lens
ESL-AL-BZKNRDM4 Area Light Bronze Knuckle 4" Round Direct Mount	ESL-CAL1-SLENS-T5 Contractor Area Light 80–185W T5 Lens
ESL-AL-WHKNRDM4 Area Light White Knuckle 4" Round Direct Mount	SHIELDS
ESL-AL-BZKNRDM5 Area Light Bronze Knuckle 5" Round Direct Mount	ESL-AL2-FSS-S-BZ AL Front Street Side Shield Small / Bronze
ESL-AL-WHKNRDM5 Area Light White Knuckle 5" Round Direct Mount	ESL-AL2-FSS-S-WH AL Front Street Side Shield Small / White
ESL-AL-BZKNSF Area Light Bronze Knuckle Slip Fitter	ESL-AL2-FBS-S-BZ AL Full Body Shield Small / Bronze
ESL-AL-WHKNSF Area Light White Knuckle Slip Fitter	ESL-AL2-FBS-S-WH AL Full Body Shield Small / White
MOUNTS (without knuckle)	ESL-AL2-HSS-S-BZ AL House Side Shield Small / Bronze
ESL-AL-BZFDM Area Light, Bronze Fixed Direct Mount	ESL-AL2-HSS-S-WH AL House Side Shield Small / White
ESL-AL-WHFDM Area Light, White Fixed Direct Mount	SENSORS
ESL-AL-BZYM Area Light, Bronze Yoke Mount	ESL-PCOF On/Off Photocell (120–277 VAC)
ESL-AL-WHYM Area Light, White Yoke Mount	ESL-PCOFHV On/Off Photocell (432–538 VAC)
ESL-AL-BZFRDM4 Area Light, Bronze 4" Fixed Round DM	ESL-PCSC Shorting Cap for Photocell
ESL-AL-WHFRDM4 Area Light, White 4" Fixed Round DM	BIRD SPIKES
ESL-AL-BZFRDM5 Area Light, Bronze 5" Fixed Round DM	ESL-AL2-BS Area Light Bird Spikes
ESL-AL-WHFRDM5 Area Light, White 5" Fixed Round DM	

Accessories

Fixed 5" Round Direct Mount ESL-AL-xxFRDM5 12/case	Fixed 4" Round Direct Mount ESL-AL-xxFRDM4 12/case	Fixed Direct Mount ESL-AL-xxFDM 12/case	Knuckle 5" Round Direct Mount ESL-AL-xxKNRDM5 12/case	Knuckle 4" Round Direct Mount ESL-AL-xxKNRDM4 12/case
Knuckle Direct Mount ESL-AL-xxKNDM 12/case	Yoke Mount ESL-AL-xxYM 12/case	Slip Fitter ESL-AL-xxKNSF 16/case	House Side Shield ESL-AL2-HSS-y-xx	Front Side Shield ESL-AL2-FSS-y-xx
Full Body Shield ESL-AL2-FBS-y-xx	Bird Spikes ESL-AL2-BS	ON/OFF Photocell 120–277 VAC ESL-PCOF	ON/OFF Photocell 432–538 VAC ESL-PCOFHV	Shorting Cap ESL-PCSC



CONTRACTOR AREA LIGHT SERIES



Factory Fixed 280 Watt Area Light — ESL-CAL-280W-1xx

Catalog Data:

ITEM#	FACTORY FIXED WATTAGE	LUMEN OUTPUT	EFFICACY (lm/W)	KELVIN (xx)	FINISH (ff)	DLC QPL CODE
ESL-CAL-80W-140-ff-T3	80W	12,640	158	(40) 4000K	(BZ) Bronze	PPF7QQVY
ESL-CAL-80W-150-ff-T3		12,800	160	(50) 5000K	(WH) White	PEVLCOC5
ESL-CAL-120W-140-ff-T3	120W	18,240	152	(40) 4000K	(BZ) Bronze	PRM6AD32
ESL-CAL-120W-150-ff-T3		18,360	153	(50) 5000K	(WH) White	PNKGHMFS
ESL-CAL-150W-140-ff-T3	150W	22,200	148	(40) 4000K	(BZ) Bronze	P5H9HYIN
ESL-CAL-150W-150-ff-T3		22,500	150	(50) 5000K	(WH) White	PJZSLPHK
ESL-CAL-185W-140-ff-T3	185W	25,794	141	(40) 4000K	(BZ) Bronze	PKC8U5OU
ESL-CAL-185W-150-ff-T3		26,833	147	(50) 5000K	(WH) White	PWGNCE6M
ESL-CAL-200W-140-ff-T3	200W	30,600	153	(40) 4000K	(BZ) Bronze	PFEHWF1M
ESL-CAL-200W-150-ff-T3		30,800	154	(50) 5000K	(WH) White	PW7G2APW
ESL-CAL-240W-140-ff-T3	240W	35,760	149	(40) 4000K	(BZ) Bronze	PRKEDMLB
ESL-CAL-240W-150-ff-T3		36,000	150	(50) 5000K	(WH) White	PA8OSP8O
ESL-CAL-280W-140-ff-T3	280W	39,480	141	(40) 4000K	(BZ) Bronze	P9Q1ZSCS
ESL-CAL-280W-150-ff-T3		39,760	142	(50) 5000K	(WH) White	PP4BNVQ1
ESL-CAL-350W-140-ff-T3	350W	48,671	141	(40) 4000K	(BZ) Bronze	P5PRLXKY
ESL-CAL-350W-150-ff-T3		50,601	147	(50) 5000K	(WH) White	P6GR9JZT

Electrical Load — Standard Voltage:

SYSTEM WATTS	INPUT CURRENT				INPUT WATTAGE	INPUT FREQUENCY	POWER FACTOR	THD	OPERATING TEMPERATURE	SURGE PROTECTION	DIMMING
	120 VAC	208 VAC	240 VAC	277 VAC							
80	0.67	0.38	0.33	0.29	120–277 VAC	50/60 Hz	>0.97 @120 VAC >0.92 @277 VAC	<13%	-40°F to 140°F (-40°C to 60°C)	4kV L/N 6kV L/N/G 10kV	0–10V
120	1.00	0.58	0.50	0.43							
150	1.25	0.72	0.63	0.54							
185	1.54	0.89	0.77	0.67							
200	1.67	0.96	0.83	0.72							
240	2.00	1.15	1.00	0.87							
280	2.33	1.35	1.17	1.01							
350	2.92	1.68	1.46	1.26							

Electrical Load — High Voltage:

SYSTEM WATTS	INPUT CURRENT			INPUT WATTAGE	INPUT FREQUENCY	POWER FACTOR	THD	OPERATING TEMPERATURE	SURGE PROTECTION	DIMMING
	277 VAC	347 VAC	480 VAC							
80	0.29	0.23	0.17	277–480 VAC	50/60 Hz	>0.95 @277 VAC >0.90 @480 VAC	<13%	-40°F to 140°F (-40°C to 60°C)	4kV L/N 6kV L/N/G 10kV	0–10V
120	0.43	0.35	0.25							
150	0.54	0.43	0.31							
185	0.67	0.53	0.39							
200	0.72	0.58	0.42							
240	0.87	0.69	0.50							
280	1.01	0.81	0.58							
350	1.26	1.01	0.73							

*Not All Part Numbers DLC Qualified. For a Complete Listing Please Consult the DLC Qualified Products List (QPL).



EPA Ratings:

TILT	SINGLE FIXTURE	TWO FIXTURES @ 90°	TWO FIXTURES @ 180°	THREE FIXTURES @ 90°	THREE FIXTURES AT 120°	FOUR FIXTURES @ 90°
80W / 120W / 150W / 185W						
0°	0.19	0.38	0.39	0.54	0.51	0.75
10°	0.57	1.16	1.19	1.41	1.29	2.25
30°	0.75	1.56	1.72	2.24	2.15	3.10
60°	1.31	2.55	2.74	3.29	3.06	5.17
90°	1.43	3.01	3.19	4.29	4.19	5.87
200W / 240W / 280W / 350W						
0°	0.21	0.51	0.57	1.53	1.36	1.85
10°	0.97	1.45	1.59	2.68	2.23	2.58
30°	1.95	2.81	3.24	4.37	4.16	6.35
60°	2.21	3.84	4.37	6.64	6.41	8.63
90°	2.32	4.66	5.13	7.65	7.64	11.19

Lumen Ambient Temperature (LAT) Multipliers:

AMBIENT		LUMEN MULTIPLIER
0 °C	32 °F	1.02
10 °C	50 °F	1.01
20 °C	68 °F	1.00
25 °C	77 °F	1.00
30 °C	86 °F	1.00
40 °C	104 °F	0.99
50 °C	122 °F	0.96

DIRECT MOUNT

	A	B	C
Direct Mount—Square	9.18"	4.88"	FLAT
Direct Mount—Round 4"	9.46"	4.88"	Ø4"
Direct Mount—Round 5"	9.38"	4.88"	Ø5"

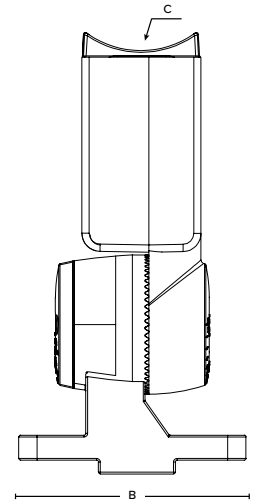
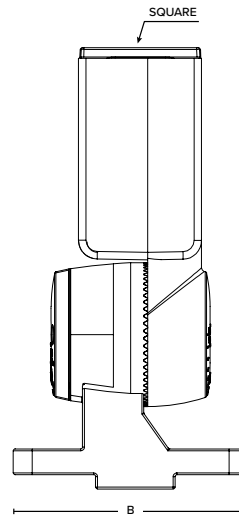
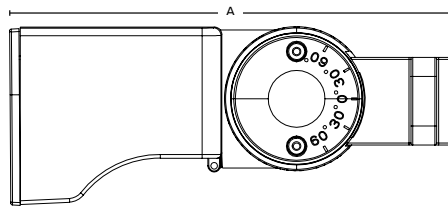
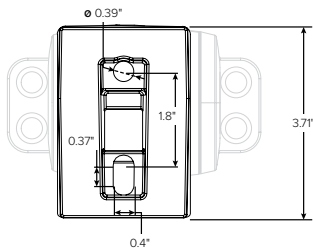

FIXED DIRECT MOUNT

	A	B	C
Direct Mount—Square	7.37"	4.87"	FLAT
Direct Mount—Round 4"	7.69"	4.87"	Ø4"
Direct Mount—Round 5"	7.69"	4.87"	Ø5"

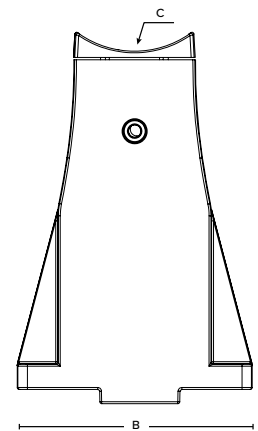
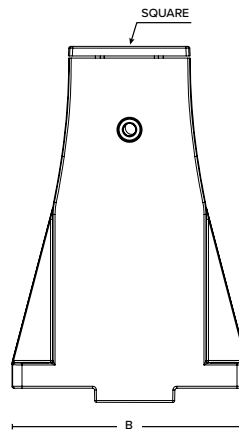
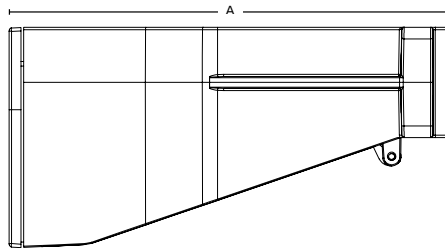
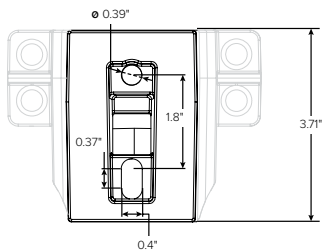

SLIP FITTER

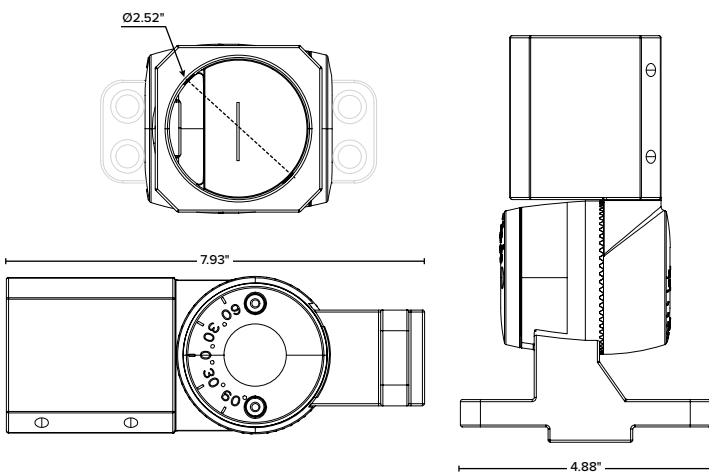

YOKE MOUNT

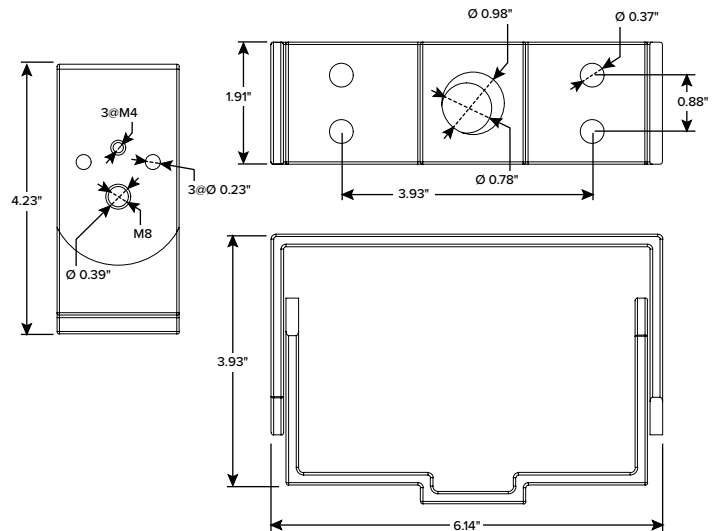

FRONT STREET SIDE SHIELD — SMALL

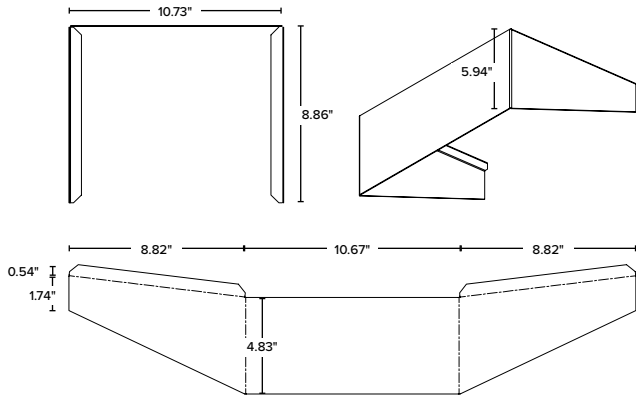

FRONT STREET SIDE SHIELD — LARGE

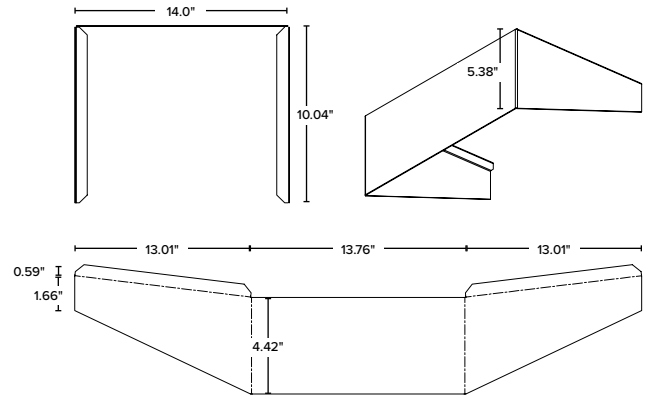

FULL BODY SHIELD — SMALL

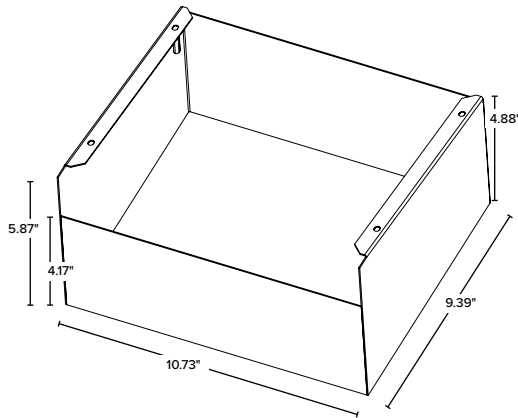

FULL BODY SHIELD — LARGE

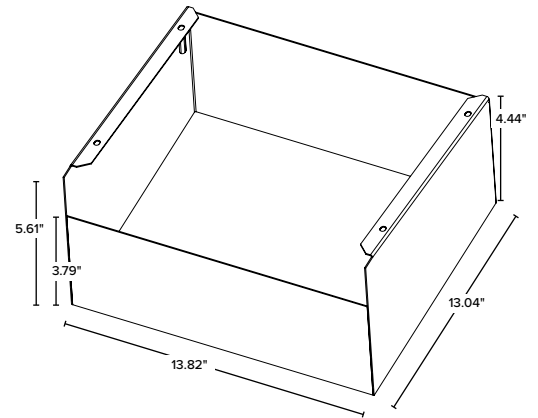

HOUSE SIDE SHIELD — SMALL

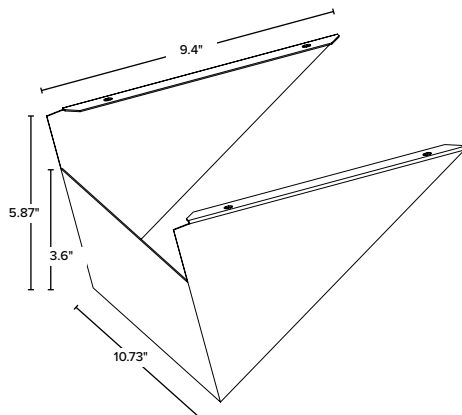

HOUSE SIDE SHIELD — LARGE

