

Key Features & Benefits:

- Glass Construction with Shatterproof Coating
- Integral Driver (Isolated)

Project: _____

Date: _____

Catalog #: _____

Notes: _____

Product Specifications:

Wattage: 38 Watts
 Kelvin: 5000K
 Lumens: Up to 5,500 Lumens
 Efficacy: Up to 145 lm/W
 Color Rendering Index (CRI): >80
 Input Voltage: 120–277 VAC
 Material: Glass with Shatterproof Coating
 Power Factor: >0.9
 L70 Lifetime 50,000 Hours Calculated per TM21
 Base Type: Fa8
 Operating Temperature: -4°F to 113°F
 Tube Dimensions (ØxL): Ø1.14" x 94.0"
 Tube Weight (lbs): 1.25 Pounds
 Case Quantity: 10

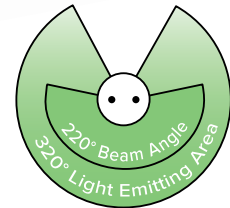
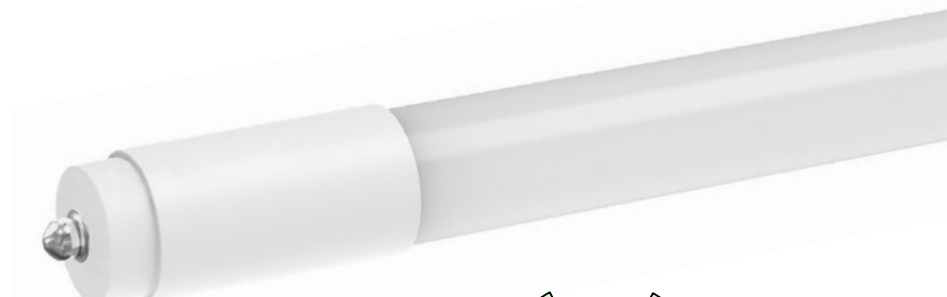

Ordering Guide:

ESL	T8	TYPE	WATTAGE	LENS	GENERATION	KELVIN
ESL	T8	B8	38W	F	1	50
	(T8) T8 Tube	(B8) Type B, 8 Foot	(38W) 38 Watts	(F) Frosted	(1) 1st Generation	(50) 5000K

T8B Wire Diagrams (Type B):

Single Pin Fa8

Fig 1. Double Ended Connection

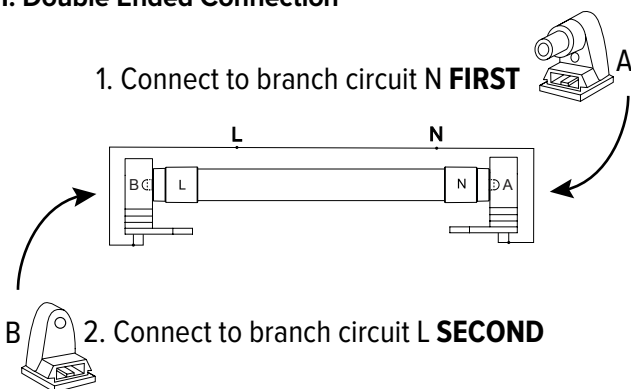

Fig 2. Retrofit with One Lamp

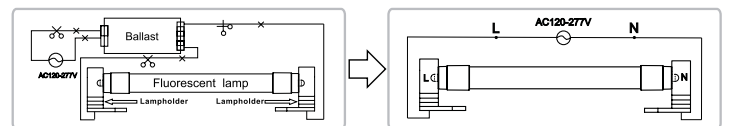
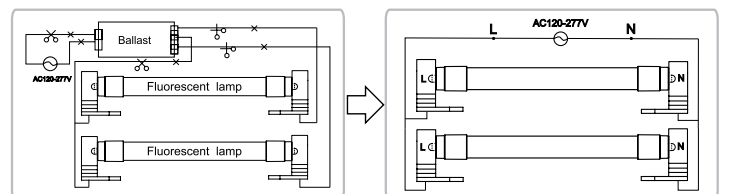

Fig 3. Retrofit with Two Lamps



Catalog Data:

SELECTABLE

ITEM#	WATTAGE	SELECTABLE KELVIN	MAX LUMEN OUTPUT	MAX EFFICACY (lm/W)	INPUT VOLTAGE	BASE	DLC QPL CODE
2 FOOT							
ESL-T8B2-7W-F13550	7W	3500K–4000K–5000K	950	136	120–277 VAC	G13	S-V1X154
ESL-T8B2-7W-F13065	7W	3000K–3500K–4000K–5000K–6500K	1,000	143	120–277 VAC	G13	PENDING
3 FOOT							
ESL-T8B3-12W-F13065	12W	3000K–3500K–4000K–5000K–6500K	1,550	129	120–277 VAC	G13	PENDING
4 FOOT							
ESL-T8B4-12W-F14065	12W	4000K–5000K–6500K	1,800	144	120–277 VAC	G13	S-K0TH7Y
ESL-T8B4-12W-F13065	12W	3000K–3500K–4000K–5000K–6500K	1,800	144	120–277 VAC	G13	PENDING
ESL-T8B4-18W-F13065	18W	3000K–3500K–4000K–5000K–6500K	2,700	146	120–277 VAC	G13	PENDING
8 FOOT							
ESL-T8B8-38W-F14065	38W	4000K–5000K–6500K	5,400	142	120–277 VAC	Fa8	S-N5AG7W
ESL-T8B8-38W-F14065-R17D	38W	4000K–5000K–6500K	5,500	145	120–277 VAC	R17D	PENDING

NON-SELECTABLE

ITEM#	WATTAGE	KELVIN	MAX LUMEN OUTPUT	MAX EFFICACY (lm/W)	INPUT VOLTAGE	BASE	DLC QPL CODE
4 FOOT							
ESL-T8B4-12W-F135	12W	3500K	1,750	146	120–277 VAC	G13	PEADIVZF
ESL-T8B4-12W-F140	12W	4000K	1,800	150	120–277 VAC	G13	PDU0TR9C
ESL-T8B4-12W-F150	12W	5000K	1,850	154	120–277 VAC	G13	PVKSR43Y
ESL-T8B4-18W-F135	18W	3500K	2,650	147	120–277 VAC	G13	PPSO08C3
ESL-T8B4-18W-F140	18W	4000K	2,700	150	120–277 VAC	G13	PQ31Y27U
ESL-T8B4-18W-F150	18W	5000K	2,750	153	120–277 VAC	G13	PODLR2RJ
8 FOOT							
ESL-T8B8-38W-F150	38W	5000K	5,500	142	120–277 VAC	Fa8	S-0G831U

Dimensions:

2 FOOT SELECTABLE

Ø1.14" x 23.22"

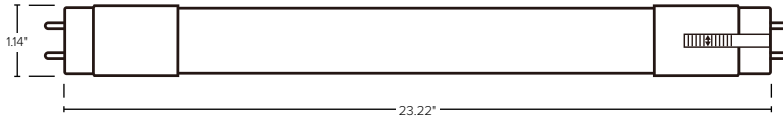

3 FOOT SELECTABLE

Ø1.14" x 35.22"

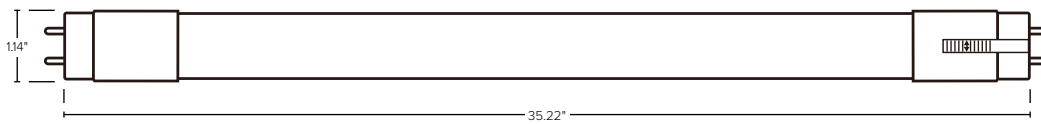

4 FOOT SELECTABLE AND NON-SELECTABLE

Ø1.14" x 47.22"

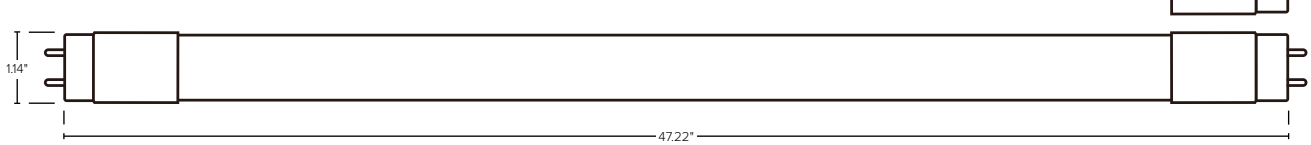

8 FOOT SELECTABLE AND NON-SELECTABLE

Ø1.14" x 93.90"

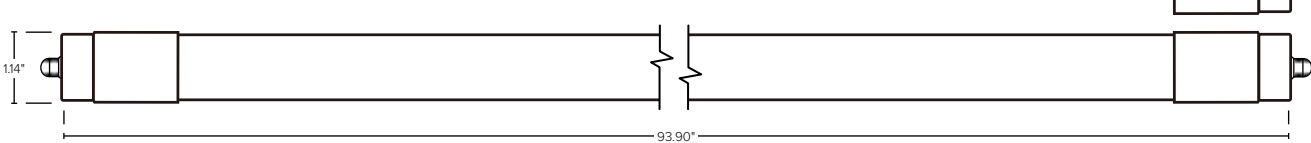

SOCKET TYPES

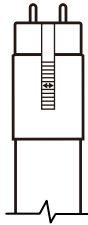

**SELECTABLE KELVIN
WITH G13 BASE:**

- ESL-T8B2-7W-F13550
- ESL-T8B2-7W-F13065
- ESL-T8B3-12W-F13065
- ESL-T8B4-12W-F14065
- ESL-T8B4-12W-F13065
- ESL-T8B4-18W-F13065
- ESL-T8B8-38W-F14065



**NON-SELECTABLE KELVIN
WITH G13 BASE:**

- ESL-T8B4-12W-F135
- ESL-T8B4-12W-F140
- ESL-T8B4-12W-F150
- ESL-T8B4-18W-F135
- ESL-T8B4-18W-F140
- ESL-T8B4-18W-F150
- ESL-T8B8-38W-F150

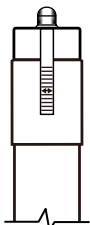

**SELECTABLE KELVIN
WITH Fa8 BASE:**

- ESL-T8B8-38W-F14065

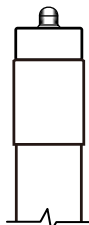

**NON-SELECTABLE KELVIN
WITH Fa8 BASE:**

- ESL-T8B8-38W-F150

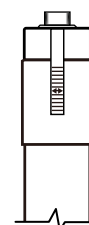

**SELECTABLE KELVIN
WITH R17D BASE:**

- ESL-T8B8-38W-F14065-R17D