

Key Features & Benefits:

- Smallest Form Factor in Mogul-Base Category
 - 15% smaller than our previous generations
- Integrated 4kA/4kV Surge Protection
- Step-Down Thermal Management Protection
 - Wattage step-down circuit automatically prevents overheating due to high increases in ambient temperatures. Wattage returns to normal as temperatures decrease.
- Omnidirectional
- Rated for Fully Enclosed Fixtures
- Wet Location Approved
- Special Adaptor Transforms Base from E26 to E39
- Direct Retrofit for HID & CFL Fixtures - For use in:
 - Low Bays
 - Flood Lights
 - Wall Packs
 - Post Tops
 - And More!



Project: _____

Date: _____

Catalog #: _____

Notes: _____



Technical Specifications:

Power: 55 Watts
 Lamp Lumen Output: Up to 6,875 Lumens
 Lamp Efficacy (lm/W): Up to 125 Lumens per Watt
 Fixture Lumen Output: Up to 5,387 Lumens
 Fixture Efficacy (lm/W): Up to 106 Lumens per Watt
 Kelvin: 3000K, 4000K, 5000K
 CRI: >80
 Input Voltage: 120-277 VAC
 Life Span: 50,000 Hours
 Beam Angle: 300°
 Base Types:
 - S-M (E26 with E39 adaptor)
 - EX39
 Operating Temperature: -4 ~ 149°F (-20 ~ 65°C)
 Power Factor: >0.95
 Total Harmonic Distortion (THD): < 20%



No Fans



No Noise



No Bugs

ITEM#	WATTS	LAMP LUMEN OUTPUT	LAMP EFFICACY (lm/W)	FIXTURE LUMEN OUTPUT	FIXTURE EFFICACY (lm/W)	KELVIN
ESL-CL-55W-430S-M	55W	6,710	122	5,024	100	3000K
ESL-CL-55W-440S-M	55W	6,765	123	5,205	103	4000K
ESL-CL-55W-450S-M	55W	6,875	125	5,387	106	5000K

ITEM#	WATTS	LAMP LUMEN OUTPUT	LAMP EFFICACY (lm/W)	FIXTURE LUMEN OUTPUT	FIXTURE EFFICACY (lm/W)	KELVIN
ESL-CL-55W-430EX39	55W	6,710	122	5,024	100	3000K
ESL-CL-55W-440EX39	55W	6,765	123	5,205	103	4000K
ESL-CL-55W-450EX39	55W	6,875	125	5,387	106	5000K

Ordering Guide:

Example Part Number: **ESL-CL-55W-430EX39**

ESL	-	CL	-	55W	-	4	-		-	
ESL		TYPE		WATTS		GENERATION		KELVIN		BASE
		CL		55W (55 Watts)		4 (4th Generation)		30 (3000K) 40 (4000K) 50 (5000K)		S-M (E26/E39) EX39 (EX39)

Options (Add as Suffix):

ESL-SP-277-1

Hard Wire Surge Protector; (100-277 VAC) Max Discharge Current: 20kA

Dimensions:

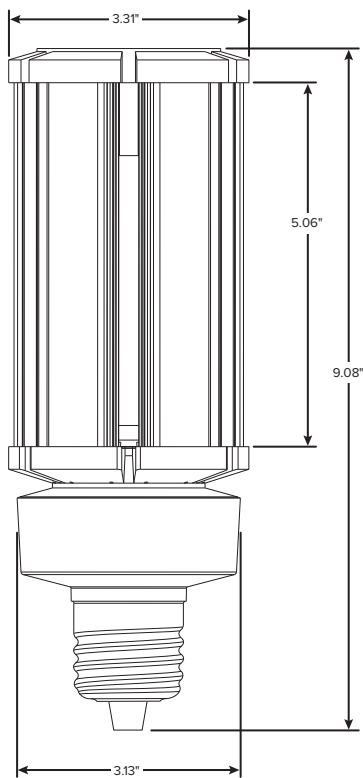

EX39 BASE

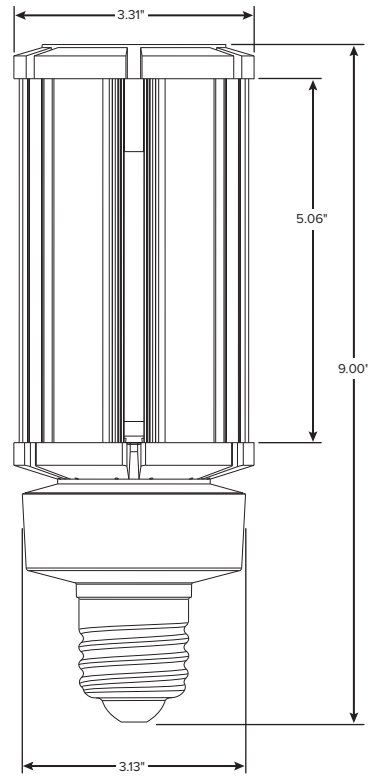

EX26 BASE