

! WARNING

1. To avoid electric shock, disconnect power at source prior to installation.
2. The installation should be performed by qualified electricians or lighting technicians.
3. Before installation, maintenance, or removal, disable all power.
4. Do not touch the fixture while it is in service.
5. If there is any problem with the fixture, turn off power and DO NOT attempt repair unless you are a qualified technician or the customer service member.

Standard Installation

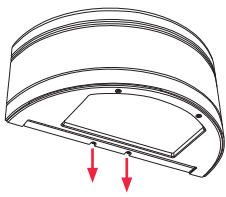

- 1** Loosen the two (2) set screws found on the bottom of the fixture housing.

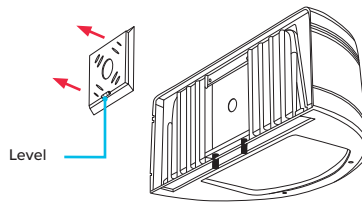

- 2** Remove the quick mount bracket, adjust it with the integrated level, and attach it to the junction box or mounting surface with appropriate hardware.

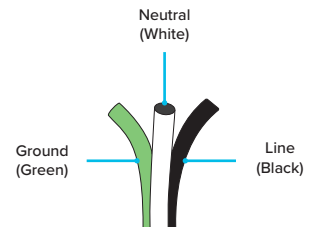

- 3** Make the wiring connections according to the Wiring Diagram (below). Push excess wire into the junction box.

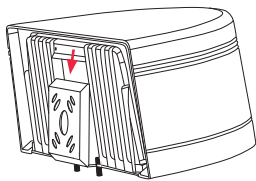

- 4** Lift the fixture and tilt it slightly toward the quick mount bracket. Hook the fixture housing onto the bracket as shown.

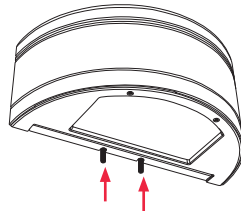

- 5** Tighten the two (2) set screws in order to secure the fixture housing to the quick mount bracket.

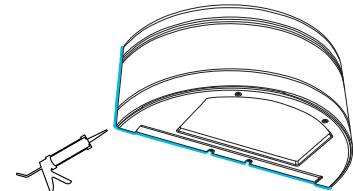

- 6** The fixture must be silicone sealed at the mounting surface. Finally, restore the power and check that the fixture is functioning properly.

Kelvin & Wattage Adjustment

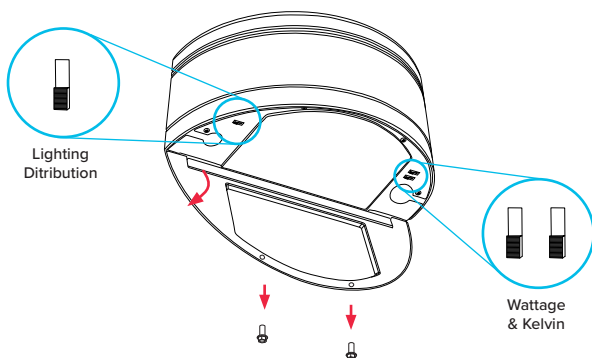

With the supply power off, remove the two screws to open the bottom cover. Adjust to the desired Wattage and Kelvin and select your Up Only / Down Only / Up & Down lighting distribution by sliding the switches on the controllers inside. Replace the cover and fix it in place with the screws.

Wiring Diagram

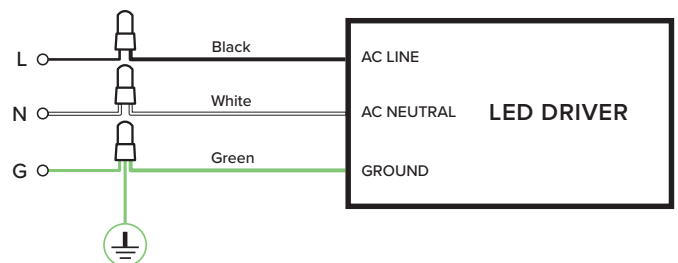

! WARNING

1. To avoid electric shock, disconnect power at source prior to installation.
2. The installation should be performed by qualified electricians or lighting technicians.
3. Before installation, maintenance, or removal, disable all power.
4. Do not touch the fixture while it is in service.
5. If there is any problem with the fixture, turn off power and DO NOT attempt repair unless you are a qualified technician or the customer service member.

Standard Installation

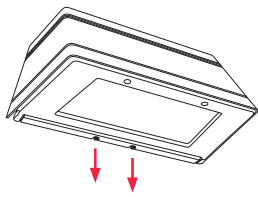

1 Loosen the two (2) set screws found on the bottom of the fixture housing.

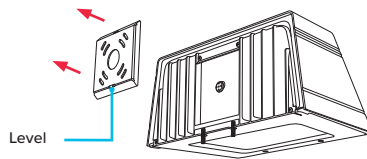

2 Remove the quick mount bracket, adjust it with the integrated level, and attach it to the junction box or mounting surface with appropriate hardware.

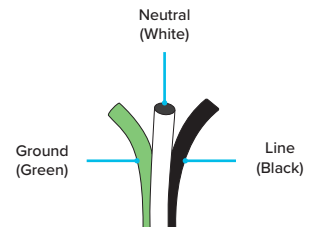

3 Make the wiring connections according to the Wiring Diagram (below). Push excess wire into the junction box.

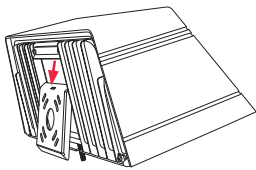

4 Lift the fixture and tilt it slightly toward the quick mount bracket. Hook the fixture housing onto the bracket as shown.

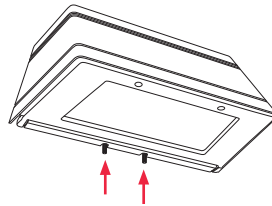

5 Tighten the two (2) set screws in order to secure the fixture housing to the quick mount bracket.

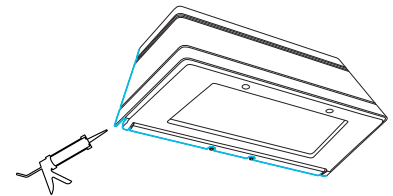

6 The fixture must be silicone sealed at the mounting surface. Finally, restore the power and check that the fixture is functioning properly.

Kelvin & Wattage Adjustment

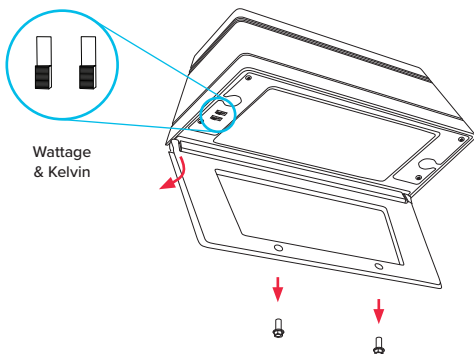

With the supply power off, remove the two screws to open the bottom cover. Adjust to the desired Wattage and Kelvin by sliding the switches on the controller inside. Replace the cover and fix it in place with the screws.

Wiring Diagram

