

! WARNING

1. To avoid electric shock, disconnect power at source prior to installation.
2. The installation should be performed by qualified electricians or lighting technicians.
3. Do not touch the fixture while it is in service.
4. Do not use any electric generator to test the fixture.
5. Proper earth grounding is required for safety.
6. If there is any problem with the fixture, turn off power and **DO NOT** attempt repair unless you are a qualified technician.

Field Adjustable

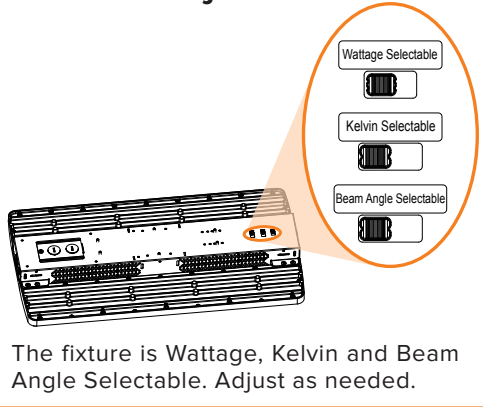

Suspension Mount

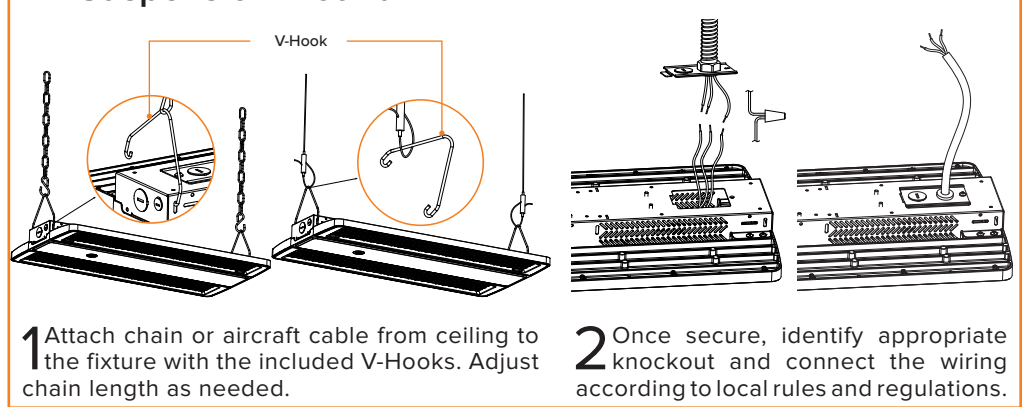

Pendant Mount

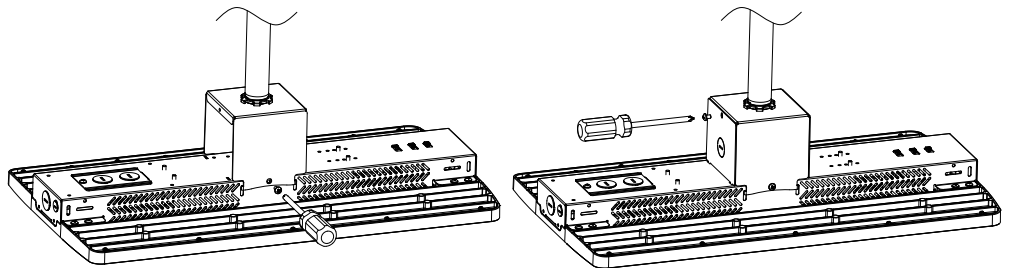
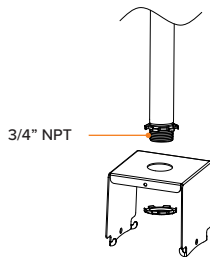

Surface Mount

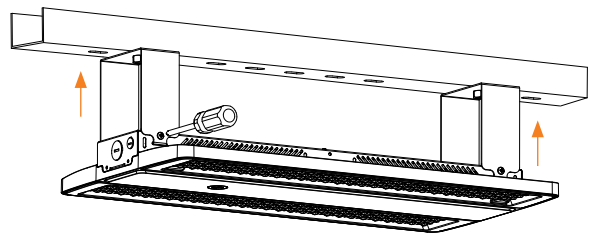
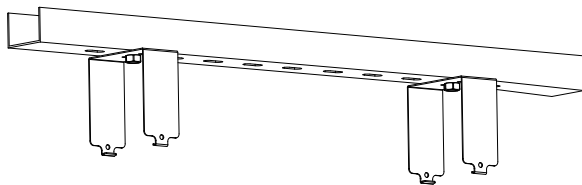

Wireguard

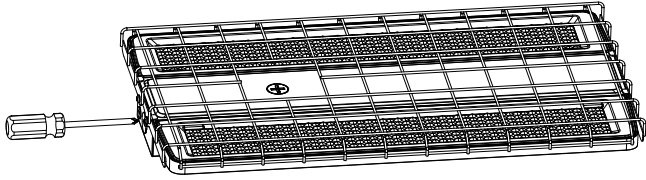

Place the optional wireguard (sold separately) onto the fixture and secure with screws.

Sensors

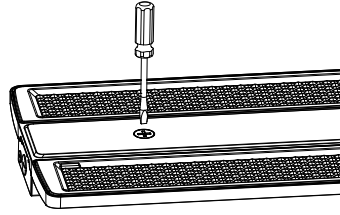

1 Remove the 1/2" cap on fixture body with a screwdriver.

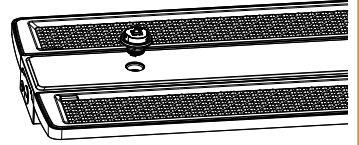

2 Twist to secure optional sensor (sold separately) into fixture.

Wiring Guide

